



TUBOS Y ACCESORIOS

TUBES AND FITTINGS / ROHRE UND FITTINGE / TUBES ET ACCESSOIRES

ÍNDICE_

INDEX_ INDEX_ ANZEICHEN

C1	Accesorios Fil-press <i>Filpress pressfittings_ Filpress raccords à sertir_ Filpress pressfittings</i>	Pag. 3-16
C2	Accesorios de Acero al carbono <i>Pressfittings_ Raccords à sertir_ Pressfittings</i>	Pag. 17-26
C3	Accesorios Capilares <i>Capillary fittings_ Accessoires capillaires_ Kapillaritäts-zubehör</i>	Pag. 27-32
C4	Abrazaderas Filtube <i>Filtube pipe clamps_ Colliers Filtube_ Filtube rohrschellen</i>	Pag. 33-36
C5	Abrazaderas <i>Other pipe clamps_ D'autres colliers_ Anderer rohrschellen</i>	Pag. 37-44
C6	Válvulas <i>Valves_ Boisseaux_ Kugelhähne</i>	Pag. 45-48
C7	Baterías <i>Battery_ Batterie_ Batterie</i>	Pag. 49-52
C8	Accesorios Roscados <i>Treaded fittings_ Accessoires filetés_ Gewindefittinge</i>	Pag. 53-60
C9	Bridas <i>Flanges_ Brides_ Flansche</i>	Pag. 61-66
C10	Accesorios de Compresión DIN-2353 <i>Compression fittings DIN-2353_ Raccords à compression_ Schneidringverschraubungen nach DIN-2353</i>	Pag. 67-72
A	Certificados <i>Certificates_ Certificats_ Bescheinigungen</i>	Pag. 73-75

CONDICIONES GENERALES DE VENTA

1. PRECIOS: *Los precios referenciados se entienden para material situado sobre agencia en Barcelona, incluido el embalaje normal. Los impuestos correrán a cargo del cliente.*

2. PEDIDOS: FILTUBE, S.A. *se reserva el derecho de rehusar pedidos inferiores a 100 Euros. Para estos pedidos la forma de pago será al contado por proforma antes de la entrega.*

3. PORTES: *Para suministros a Península y Baleares, de importe igual ó superior a 900 Euros en accesorios y 1500 Euros si contienen tubería, los portes correrán a cargo de FILTUBE, S.A.*

En los suministros a Canarias, Ceuta y Melilla, serán a portes pagados cuando el importe del material entregado sea superior a 1.500 Euros.

En los suministros a territorio extranjero, el pago de los portes se ajustará a lo que se pacte en las condiciones particulares.

4. DEVOLUCIONES: FILTUBE, S.A. *No está obligada a aceptar ninguna devolución del material, salvo en los supuestos de productos defectuosos. En los casos de error en la entrega FILTUBE, S.A. no aceptará ninguna devolución transcurridos 15 días desde la fecha de entrega.*

En los supuestos en que FILTUBE, S.A. acepte la devolución y el abono del material por causas distintas a las enumeradas en el epígrafe precedente, los portes de la devolución serán satisfechos por el cliente.

Por lo que respecta al importe del abono, FILTUBE, S.A. repercutirá, sobre el mismo, los gastos de recepción y manipulación, que en ningún caso serán superiores al 30% del precio de venta del producto.

5. CERTIFICACIONES SOBRE LAS MATERIAS PRIMAS: *Las certificaciones de calidad de las materias primas empleadas no serán entregadas, salvo petición expresa del comprador, según sus indicaciones y a sus expensas.*

6. RESPONSABILIDAD: FILTUBE, S.A. *Garantiza sus sistemas de instalación (Accesorios FILPRESS y Accesorios Capilares), siempre y cuando los materiales utilizados para la instalación (Tubo y Accesorios) sean todos pertenecientes a FILTUBE, S.A.*

FILTUBE, S.A. *Verifica todos sus productos antes de su salida. Sin embargo, se reemplazarán gratuitamente cualquiera de aquellos en los que se observe defecto, o no sean conformes con el pedido, a condición de recibir aviso de la devolución dentro de los 15 días siguientes a la entrega de dicha mercancía.*

La mercancía viajará por cuenta y riesgo del comprador. En caso de avería, menoscabo, retraso o error cualquiera, el destinatario dirigirá su acción solamente contra el transportista.

En cualquier caso no previsto en estas condiciones generales, nuestra empresa se acoge a las disposiciones legales vigentes que regulan este tipo de transacciones comerciales.

Todas las operaciones están garantizadas por Crédito y Caución.



ACCESORIOS FIL-PRESS

FIL-PRESS PRESSFITTINGS_ FIL-PRESS RACCORDS À SERTIR_ FIL-PRESS PRESSFITTINGS

ACCESORIOS FIL-PRESS
PRESSFITTINGS
RACCORDS À SERTIR
PRESSFITTINGS

C1

TUBOS

FILTUBE PIPES_ FILTUBE LES TUYAUX_ ROHRLEITUNGEN FILTUBE

Ø x ESPESOR Ø X THICKNESS Ø X ÉPAISSEUR Ø X DICKE	TUBO BRILLANTE PICKLED PIPE TUBE STANDARD STANDAR ROHR	TUBO PULIDO MIRROR POLISHED PIPE TUBE POLI MIRROR POLIERTES ROHR	PESO WEIGHT POID GEWICHT	PRESIÓN DE TRABAJO WORKING PRESSURE PRESSION DE SERVICE ARBEITSDRUCK	€/Ud.
--	---	---	-----------------------------------	---	-------

TUBO SANITARIO SEGÚN NORMA EN-10312 (AISI-304L)



MM.	REF.	REF.	(+/-) KG/M	KG/CM	€/Ud.
10 x 0,6	10210X06	102P10X06	0,141	133	*
12 x 0,6	10212X06	102P12X06	0,171	111	*
15 x 0,6	10215X06	102P15X06	0,216	88	*
18 x 0,7	10218X07	102P18X07	0,303	86	*
22 x 0,7	10222X07	102P22X07	0,373	70	*
28 x 0,8	10228X08	102P28X08	0,545	63	*
35 x 1,0	10235X10	102P35X10	0,851	63	*
42 x 1,2	10242X12	102P42X12	1,230	63	*
54 x 1,2	10254X12	102P54X12	1,470	49	*
76,1 x 2,0	122761X20	122P761X20	3,711	58	*
88,9 x 2,0	122889X20	122P889X20	4,352	49	*
108 x 2,0	122108X20	122P108X20	5,328	41	*

TUBO SANITARIO SEGÚN NORMA EN-10312 (AISI-316L)



MM.	REF.	REF.	(+/-) KG/M	KG/CM	€/Ud.
10 x 0,6	10410X06	104P10X06	0,141	133	*
12 x 0,6	10412X06	104P12X06	0,171	111	*
15 x 0,6	10415X06	104P15X06	0,216	88	*
18 x 0,7	10418X07	104P18X07	0,303	86	*
22 x 0,7	10422X07	104P22X07	0,373	70	*
28 x 0,8	10428X08	104P28X08	0,545	63	*
35 x 1,0	10435X10	104P35X10	0,851	63	*
42 x 1,2	10442X12	104P42X12	1,230	63	*
54 x 1,2	10454X12	104P54X12	1,470	49	*

Producido según norma EN-10312 - Precios en Euros/Metro - Longitud estándar 5 m. _Produced according to the EN-10312 norm - Price in Euros/Meter - Standard length 5 mt._
Produit selon EN-10312 - Prix en Euro/Metre - Longueur Standard de 5 metres. _Produziert gemäss EN-10312 - Preis in Euros / mtr - Standard länge 5 meter _

TUBO SANITARIO DVGW (AISI-316L)

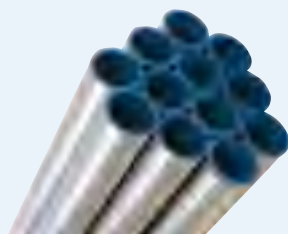

MM.	REF.	REF.	(+/-) KG/M	KG/CM	€/Ud.
15 x 1,0	12415X10	124P15X10	0,351	147	*
18 x 1,0	12418X10	124P18X10	0,426	123	*
22 x 1,2	12422X12	124P22X12	0,625	121	*
28 x 1,2	12428X12	124P28X12	0,805	95	*
35 x 1,5	12435X15	124P35X15	1,258	95	*
42 x 1,5	12442X15	124P42X15	1,521	79	*
54 x 1,5	12454X15	124P54X15	1,972	61	*
76,1x2,0	124761X20	124P761X20	3,711	58	*
88,9x2,0	124889X20	124P889X20	4,352	49	*
108x2,0	124108X20	124P108X20	5,328	41	*

Producido según norma DVGW - Precios en Euros/Metro - Longitud estándar 6 m. _Produced according to the DVGW norm - Price in Euros/Meters - Standard length 6 meter._
Produit selon DVGW - Prix en Euro/Metre - Longueur Standard de 6 metres. _Produziert gemäss DVGW Norm - Preis in Euros / mtr - Standard länge 6 mtr._

ACCESORIOS FILPRESS (ACERO INOXIDABLE AISI-316)_

FILPRESS PRESSFITTINGS (STAINLESS STEEL AISI-316)_ FILPRESS RACCORDS À SERTIR (ACIER INOXYDABLE AISI-316)_
FILPRESS PRESSFITTINGS (ROSTFREIEM EDELSTAHL AISI-316)

REF.	Ø	A	B	C	PIEZAS/ BOLSA PIECES/ BAG PIECES/ SACHETS STÜCKE/ BEUTEL	€/Ud.
------	---	---	---	---	---	-------

CURVA 90° HH



26C90HH15	15	16	49	28	25	3,50
26C90HH18	18	18	52	32	25	3,92
26C90HH22	22	21	60	38	15	4,50
26C90HH28	28	25,5	78	50	5	5,74
26C90HH35	35	28	100	68	5	9,26
26C90HH42	42	34	119	80	5	14,54
26C90HH54	54	36	150	108	3	20,81
26C90HH76	76,1	54	188	115	1	55,97
26C90HH88	88,9	56	219	135	1	72,35
26C90HH108	108	79	266	165	1	98,02

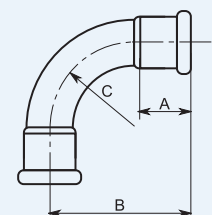

CURVA 90° HM



26C90HM15	15	25,5	55	28	25	3,89
26C90HM18	18	25	57	32	25	4,06
26C90HM22	22	25	66	38	15	4,57
26C90HM28	28	41	82	50	5	6,12
26C90HM35	35	35	110	68	5	9,05
26C90HM42	42	49	133	80	5	14,13
26C90HM54	54	40	168	108	3	20,26
26C90HM76	76,1	70	215	115	1	47,88
26C90HM88	88,9	85	240	135	1	63,75
26C90HM108	108	77	290	162	1	92,18

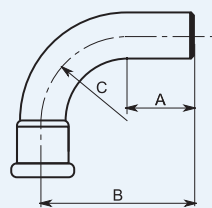

CODO 90° HH RADIO CORTO



26C90HHRC42	42	31	94	55	5	13,01
26C90HHRC54	54	35	108	65	5	20,93
26C90HHRC76	76	53	162	91	1	44,38

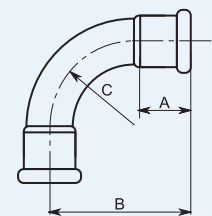

CODO 90° HM RADIO CORTO



26C90HMRC42	42	33	103	55	5	13,71
26C90HMRC54	54	37	110	65	5	20,16
26C90HMRC76	76	63	183	91	1	44,05

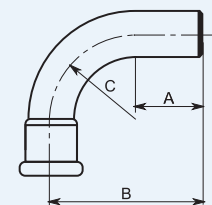

ACCESORIOS FILPRESS (ACERO INOXIDABLE AISI-316)

FILPRESS PRESSFITTINGS (STAINLESS STEEL AISI-316) FILPRESS RACCORDS À SERTIR (ACIER INOXYDABLE AISI-316)
FILPRESS PRESSFITTINGS (ROSTFREIEM EDELSTAHL AISI-316)

REF.	Ø	A	B	C	PIEZAS/ BOLSA PIECES/ BAG PIÈCES/ SACHETS STÜCKE/ BEUTEL	€/Ud.
------	---	---	---	---	---	-------

CURVA 45° HH



26C45HH15	15	16	32	28	25	3,43
26C45HH18	18	18,5	33	32	25	3,79
26C45HH22	22	21,5	37	38	25	4,53
26C45HH28	28	25,5	47	50	10	5,69
26C45HH35	35	27	63	68	10	8,92
26C45HH42	42	33	72	80	10	14,28
26C45HH54	54	34	85	108	5	18,86
26C45HH76	76,1	67	138	115	1	56,57
26C45HH88	88,9	58	134	135	1	66,86
26C45HH108	108	72	165	165	1	87,60

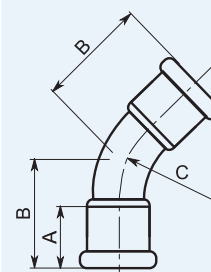

CURVA 45° HM



26C45HM15	15	25	36,5	28	25	3,75
26C45HM18	18	26	36	32	25	4,02
26C45HM22	22	32	43,5	38	25	4,79
26C45HM28	28	32	50,3	50	10	6,03
26C45HM35	35	38	75	68	10	9,17
26C45HM42	42	40	80	80	10	14,13
26C45HM54	54	42	106	108	5	18,31
26C45HM76	76,1	71	140	115	1	49,28
26C45HM88	88,9	64	165	135	1	64,66
26C45HM108	108	79	190	165	1	84,90

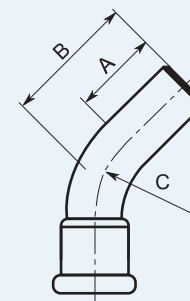

MANGUITO HH



26M15	15	15	39,5	-	25	2,16
26M18	18	16,5	44	-	25	2,41
26M22	22	20	51,5	-	25	2,79
26M28	28	22,5	61	-	10	3,51
26M35	35	26	68	-	10	4,83
26M42	42	32	82	-	10	7,49
26M54	54	36	90	-	5	9,60
26M76	76,1	53	148	-	1	32,88
26M88	88,9	56	170	-	1	36,95
26M108	108	73	197	-	1	55,01

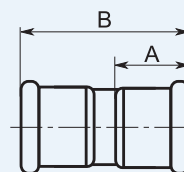

TE IGUAL



26T15	15	16	67	34	25	6,42
26T18	18	17	68,5	34	15	6,69
26T22	22	20	75	39	15	7,07
26T28	28	26	91	46,5	5	8,98
26T35	35	29	110	54	5	11,61
26T42	42	33	117	64	5	17,16
26T54	54	33	146	74,5	3	21,66
26T76	76,1	54	230	115	1	82,21
26T88	88,9	58,5	260	127	1	88,87
26T108	108	71	310	160	1	115,99

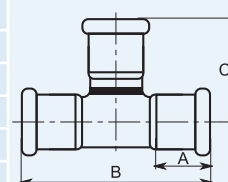

ACCESORIOS FILPRESS (ACERO INOXIDABLE AISI-316)_

FILPRESS PRESSFITTINGS (STAINLESS STEEL AISI-316)_ FILPRESS RACCORDS À SERTIR (ACIER INOXYDABLE AISI-316)_
FILPRESS PRESSFITTINGS (ROSTFREIEM EDELSTAHL AISI-316)

REF.	Ø	A	B	C	PIEZAS/ BOLSA PIECES/ BAG PIÈCES/ SACHETS STÜCKE/ BEUTEL	€/Ud.
------	---	---	---	---	---	-------

MANGUITO SINFIN



26MST15	15	-	78	-	10	3,79
26MST18	18	-	77	-	15	4,14
26MST22	22	-	82,5	-	15	5,83
26MST28	28	-	89,5	-	10	7,25
26MST35	35	-	102	-	10	8,59
26MST42	42	-	121	-	10	10,18
26MST54	54	-	142	-	5	14,15
26MST76	76,1	-	230	-	1	80,51
26MST88	88,9	-	260	-	1	90,95
26MST108	108	-	310	-	1	99,82

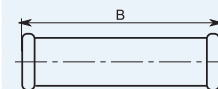

BRIDA ADAPTADOR



26BA15	15	47	95	65	1	34,95
26BA18	18	47	95	65	1	39,05
26BA22	22	50	105	75	1	43,74
26BA28	28	29	115	85	1	58,43
26BA35	35	64	140	100	1	77,74
26BA42	42	42	150	110	1	69,44
26BA54	54	47	165	125	1	91,65
26BA76	76	71	185	145	1	97,58
26BA88	88,9	79	200	160	1	122,23
26BA108	108	97	220	180	1	153,48

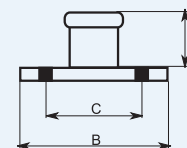

ACCESORIOS FILPRESS (ACERO INOXIDABLE AISI-316)_

FILPRESS PRESSFITTINGS (STAINLESS STEEL AISI-316)_ FILPRESS RACCORDS À SERTIR (ACIER INOXYDABLE AISI-316)_
FILPRESS PRESSFITTINGS (ROSTFREIEM EDELSTAHL AISI-316)

REF.	Ø	A	B	C	PIEZAS/ BOLSA PIECES/ BAG PIECES/ SACHETS STÜCKE/ BEUTEL	€/Ud.
------	---	---	---	---	---	-------

REDUCCIÓN MH



26RE18X15	18X15	23	52	23	25	3,53
26RE22X15	22X15	24	56,5	24	25	3,73
26RE22X18	22X18	22	55	25	10	3,94
26RE28X15	28X15	24	60	26	10	4,78
26RE28X18	28X18	24	59	27	10	4,99
26RE28X22	28X22	26,5	60	27	10	4,66
26RE35X22	35X22	26	70	30	10	5,82
26RE35X28	35X28	31	70	30	10	5,77
26RE42X22	42X22	25,5	82	36	10	8,10
26RE42X28	42X28	29	82	39	10	8,24
26RE42X35	42X35	34	82	41	10	7,92
26RE54X15	54X15	26,5	96	45	10	18,60
26RE54X22	54X22	26	102	41	10	11,09
26RE54X28	54X28	30,5	94	41	10	11,34
26RE54X35	54X35	34	91	39	10	11,81
26RE54X42	54X42	39	97	47	10	11,54
26RE76X54	76,1X54	42	150	80	1	33,21
26RE88X54	88,9X54	43	166	70	1	37,20
26RE88X76	88,9X76	71	163	80	1	48,39
26RE108X54	108X54	117	245	42	1	42,04
26RE108X76	108X76,1	71	203	95	1	54,14
26RE108X88	108X88,9	80	205	95	1	56,35

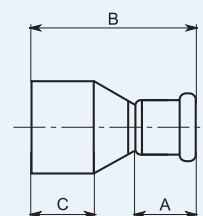

TE ROSCADA H



26TH15X12	15X1/2"	19	63,5	33	10	9,99
26TH18X12	18X1/2"	17	68,5	36	10	10,24
26TH18X34	18X3/4"	17	67,5	39	10	11,07
26TH22X12	22X1/2"	21	75	36,5	10	9,65
26TH22X34	22X3/4"	20	75	42	10	12,32
26TH28X12	28X1/2"	23	90	36,5	10	11,81
26TH28X34	28X3/4"	23	90	44	10	14,49
26TH35X12	35X1/2"	26,5	110	39,5	5	14,96
26TH35X34	35X3/4"	27,5	110	49	5	16,34
26TH42X12	42X1/2"	32,5	117	44	5	15,71
26TH42X34	42X3/4"	33	116	48,5	5	18,24
26TH54X12	54X1/2"	35	146	48	3	21,14
26TH54X34	54X3/4"	35	145	58,5	3	20,87
26TH54X20	54X2"	33	146	85	3	37,90
26TH76X34	76,1X3/4"	54	230	70	1	72,23
26TH76X2	76,1X2"	54	230	98	1	77,25
26TH88X34	88,9X3/4"	55,5	260	76	1	82,19
26TH88X20	88,9X2"	60,5	260	100	1	87,19
26TH108X34	108X3/4"	79	310	86	1	97,52
26TH108X20	108X2"	69	310	112	1	105,05

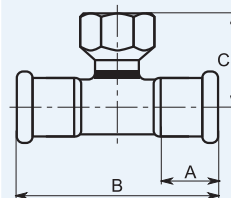

ACCESORIOS FILPRESS (ACERO INOXIDABLE AISI-316)_

FILPRESS PRESSFITTINGS (STAINLESS STEEL AISI-316)_ FILPRESS RACCORDS À SERTIR (ACIER INOXYDABLE AISI-316)_
FILPRESS PRESSFITTINGS (ROSTFREIEM EDELSTAHL AISI-316)

REF.	Ø	A	B	C	PIEZAS/ BOLSA PIECES/ BAG PIECES/ SACHETS STÜCKE/ BEUTEL	€/Ud.
------	---	---	---	---	---	-------

TE REDUCCIÓN HHH

26TR18X15	18X15	16,5	68,5	38,5	15	6,68
26TR22X15	22X15	20	75	38,5	15	7,06
26TR22X18	22X18	19	75	36,5	15	7,29
26TR28X15	28X15	21	90	41,5	5	8,02
26TR28X18	28X18	23	91	38,5	5	8,63
26TR28X22	28X22	21	90	43,5	5	8,55
26TR35X15	35X15	29	110	41	5	10,06
26TR35X18	35X18	27	120	42	5	10,12
26TR35X22	35X22	25	110	47	5	10,23
26TR35X28	35X28	27	110	49	5	11,18
26TR42X22	42X22	30	117	51	5	13,67
26TR42X28	42X28	30	117	54	5	14,63
26TR42X35	42X35	30	117	59	5	15,21
26TR54X22	54X22	33	145	57	5	19,05
26TR54X28	54X28	33	145	60	4	19,56
26TR54X35	54X35	33	146	65	4	20,54
26TR54X42	54X42	33	146	70	4	21,43
26TR76X22	76,1X22	54	230	67	1	62,97
26TR76X28	76,1X28	66	245	73	1	64,08
26TR76X35	76,1X35	53	230	77	1	65,65
26TR76X42	76,1X42	53	230	82	1	66,98
26TR76X54	76,1X54	53	230	85	1	68,96
26TR88X22	88,9X22	82	277	74	1	72,46
26TR88X28	88,9X28	56	260	81	1	74,56
26TR88X35	88,9X35	60	260	83	1	76,42
26TR88X42	88,9X42	60	260	85	1	78,83
26TR88X54	88,9X54	60	260	88	1	80,84
26TR88X76	88,9X76	58	260	117	1	86,83
26TR108X22	108X22	69	310	85	1	92,53
26TR108X28	108X28	75	310	90	1	96,31
26TR108X35	108X35	71	310	90	1	97,35
26TR108X42	108X42	73	310	95	1	99,23
26TR108X54	108X54	67,5	310	105	1	104,44
26TR108X76	108X76,1	75	310	126	1	118,61
26TR108X88	108X88,9	75	310	136	1	123,99

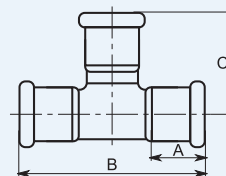

ACCESORIOS FILPRESS (ACERO INOXIDABLE AISI-316)

FILPRESS PRESSFITTINGS (STAINLESS STEEL AISI-316)_ FILPRESS RACCORDS À SERTIR (ACIER INOXYDABLE AISI-316)_
FILPRESS PRESSFITTINGS (ROSTFREIEM EDELSTAHL AISI-316)

REF.	Ø	A	B	C	PIEZAS/ BOLSA PIECES/ BAG PIECES/ SACHETS STÜCKE/ BEUTEL	€/Ud.
------	---	---	---	---	---	-------

RACOR 2 PIEZAS CON CUELLO



26RP15X12	15X1/2"	19	36,5	-	25	6,73
26RP15X34	15X3/4"	19	43	-	15	8,15
26RP18X12	18X1/2"	20	38	-	15	7,30
26RP18X34	18X3/4"	21,5	37	-	10	7,99
26RP22X34	22X3/4"	22	43	-	10	8,41
26RP22X10	22X1"	21,5	51	-	15	9,72
26RP28X10	28X1"	24	52	-	10	10,37
26RP28X114	28X1 1/4"	28	48	-	10	12,11
26RP35X114	35X1 1/4"	30	52	-	10	14,45
26RP42X112	42X1 1/2"	32	57,5	-	10	18,48
26RP54X20	54X2"	35	77	-	5	25,08
26RP76X212	76,1X1/2"	53,5	114,5	-	1	60,14

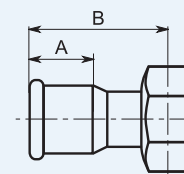

RACOR DOS PIEZAS CON JUNTA PLANA



26RPJP15X12	15X1/2"	19,5	37	-	25	7,13
26RPJP15X34	15X3/4"	19,5	38,5	-	15	8,34
26RPJP18X12	18X1/2"	17	33,5	-	15	7,63
26RPJP18X34	18X3/4"	17	38	-	10	8,13
26RPJP22X34	22X3/4"	22,5	41	-	10	9,35
26RPJP22X10	22X1"	27	43	-	15	10,31
26RPJP28X10	28X1"	24	50,5	-	10	11,37
26RPJP28X114	28X1 1/4"	24	48	-	10	12,11
26RPJP35X114	35X1 1/4"	29	52	-	10	14,18
26RPJP42X112	42X1 1/2"	33	57	-	10	17,48
26RPJP42X20	42X2"	36	69	-	5	19,53
26RPJP54X20	54X2"	36	76	-	5	23,94
26RPJP54X212	54X2 1/2"	36	133	-	1	37,38
26RPJP76X212	76,1X2 1/2"	53,5	113	-	1	60,14

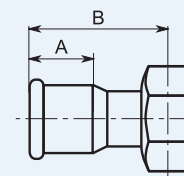

UNIÓN MACHO



26UM15X12	15X1/2"	17,5	42	11	10	5,33
26UM18X12	18X1/2"	17,5	47,5	13	10	5,84
26UM18X34	18X3/4"	16	50,5	14,5	10	6,68
26UM22X34	22X3/4"	20	54	15	10	6,63
26UM22X10	22X1"	21	58	17	10	8,00
26UM28X10	28X1"	23,5	62	18	10	8,19
26UM35X114	35X1 1/4"	29	67	15	10	10,70
26UM42X114	42X1 1/4"	33	71	15	10	15,03
26UM42X112	42X1 1/2"	30	57	16	10	13,20
26UM54X112	54X1 1/2"	36	84,5	16,5	5	21,48
26UM54X20	54X2"	35	71	22,5	5	18,71
26UM76X212	76,1X2 1/2"	53,5	123,5	29	1	59,74
26UM88X30	88,9X3"	60	137	33	1	88,94

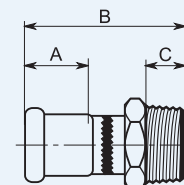

ACCESORIOS FILPRESS (ACERO INOXIDABLE AISI-316)_

FILPRESS PRESSFITTINGS (STAINLESS STEEL AISI-316)_ FILPRESS RACCORDS À SERTIR (ACIER INOXYDABLE AISI-316)_
FILPRESS PRESSFITTINGS (ROSTFREIEM EDELSTAHL AISI-316)

REF.	Ø	A	B	C	PIEZAS/ BOLSA PIECES/ BAG PIECES/ SACHETS STÜCKE/ BEUTEL	€/Ud.
------	---	---	---	---	---	-------

UNIÓN HEMBRA



26UH15X12	15X1/2"	19	48,5	12,5	10	6,29
26UH18X12	18X1/2"	18	46,5	12,5	10	6,14
26UH18X34	18X3/4"	16	52	13,5	10	7,23
26UH22X34	22X3/4"	21	56	14,5	10	7,03
26UH22X10	22X1"	20,5	53,5	18	10	9,36
26UH28X10	28X1"	23,5	57,5	16,5	10	9,84
26UH35X114	35X1 1/4"	30	79	20	10	12,72
26UH42X114	42X1 1/4"	32,5	83	21	10	18,90
26UH42X112	42X1 1/2"	31	79	23	10	15,98
26UH54X112	54X1 1/2"	36	87	23,5	5	26,31
26UH54X20	54X2"	34,5	98	31,5	5	23,64
26UH76X212	76,1X2 1/2"	53,5	127,5	30	1	66,48

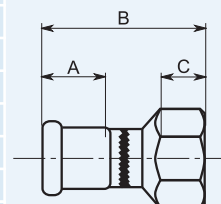

CODO HEMBRA



26CH15X12	15X1/2"	19	49,5	27	15	6,67
26CH18X12	18X1/2"	16	48	27	15	6,96
26CH22X34	22X3/4"	22	56	30	15	8,82
26CH28X12	28X1/2"	25	57	27,5	5	10,38

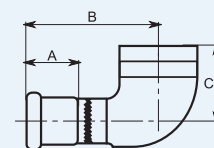

CODO MACHO



26CM15X12	15X1/2"	18	49	36	15	6,79
26CM18X12	18X1/2"	23	48	36	15	7,22
26CM42X112	42X1 1/2"	31	136	68	5	23,89
26CM54X20	54X2"	97	155	70	3	34,40

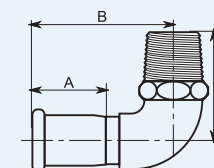

CODO PLACA



26CF15X12	15X1/2"	18,5	47,5	27	15	7,17
26CF18X12	18X1/2"	20	48	27	15	7,42
26CF22X34	22X3/4"	24	53,5	31	10	8,92
26CF28X10	28X1"	28	68,5	39	10	11,59

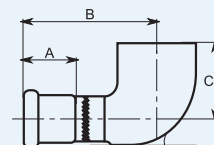

CURVA 2 PIEZAS





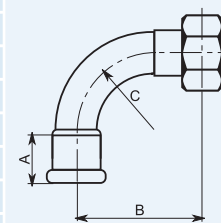



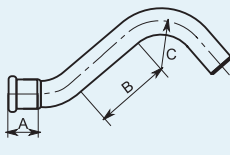

26CP15X12	15X1/2"	16,5	45	28	25	12,33
26CP18X12	18X1/2"	19	51	32	15	14,57
26CP18X34	18X3/4"	19	54,5	32	10	15,65
26CP22X34	22X3/4"	22	67,5	38	10	16,63
26CP22X10	22X1"	22	72,5	38	10	18,21

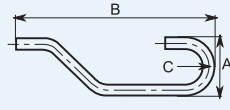

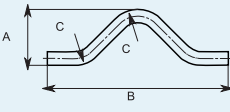
ACCESORIOS FILPRESS (ACERO INOXIDABLE AISI-316)_

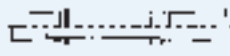
FILPRESS PRESSFITTINGS (STAINLESS STEEL AISI-316)_ FILPRESS RACCORDS À SERTIR (ACIER INOXYDABLE AISI-316)_
FILPRESS PRESSFITTINGS (ROSTFREIEM EDELSTAHL AISI-316)

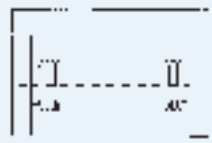
	REF.	Ø	A	B	C	PIEZAS/ BOLSA PIECES/ BAG PIECES/ SACHETS STÜCKE/ BEUTEL	€/Ud.	
CURVA DESVIACIÓN MH								
	26CDHM15	15	15,5	43	28	10	9,32	
	26CDHM18	18	18	51	32	5	10,40	
	26CDHM22	22	19,5	43	38	5	11,50	
CURVA DESVIACIÓN CISNE								
	26CC15	15	98	306	41	1	8,88	
	26CC18	18	144	370	63	1	9,49	
	26CC22	22	170	410	73	1	10,42	
SALTATUBOS								
	26ST15	15	62	200	28	10	7,92	
	26ST18	18	73	230	32	10	8,97	
	26ST22	22	75	255	38	10	10,55	
	26ST28	28	94	280	50	5	12,82	
COMPENSADOR DE DILATACIÓN 15 - 24								
	26CD15	15	320	25	-	1	58,97	
	26CD18	18	320	25	-	1	60,73	
	26CD22	22	320	30	-	1	63,00	
	26CD28	28	325	38	-	1	79,13	
	26CD35	35	340	48	-	1	106,60	
	26CD42	42	340	54	-	1	124,74	
	26CD54	54	400	71	-	1	174,39	
COMPENSADOR DE DILATACIÓN 76,1 - 108								
	26CD76	76,1	286	-	-	1	463,69	
	26CD88	88,9	290	-	-	1	592,22	
	26CD108	108	280	-	-	1	816,50	

ACCESORIOS FILPRESS (ACERO INOXIDABLE AISI-316)_

FILPRESS PRESSFITTINGS (STAINLESS STEEL AISI-316)_ FILPRESS RACCORDS À SERTIR (ACIER INOXYDABLE AISI-316)_
FILPRESS PRESSFITTINGS (ROSTFREIEM EDELSTAHL AISI-316)

REF.	Ø	A	B	C	PIEZAS/ BOLSA PIECES/ BAG PIECES/ SACHETS STÜCKE/ BEUTEL	€/Ud.
------	---	---	---	---	---	-------

CRUZ REDUCIDA



26CR18X28X28X18	18X28X28X18	79	98	35	1	15,56
26CR28X42X42X28	28X42X42X28	108	118	50	1	23,76
26CR28X54X54X28	28X54X54X28	118	170	61	1	29,93
26CR28X76X76X28	28X76X76X28	142	265	84	1	47,61
26CR28X88X88X28	28X88X88X28	156	290	100	1	56,91

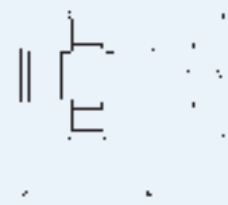

RACOR 3 PIEZAS CÓNICO



26RTP42	42	60	127	-	-	32,88
26RTP54	54	58	146	-	-	44,97



TAPONES



26TA15	15	19	34,5	-	25	5,85
26TA18	18	22	39	-	25	6,09
26TA22	22	21,5	37,5	-	25	6,64
26TA28	28	26,5	43	-	25	8,93
26TA35	35	29	49	-	25	10,49
26TA42	42	31	54,5	-	10	13,47
26TA54	54	34	63	-	10	18,21
26TA76	76,1	53,5	97	-	1	34,35
26TA88	88,9	57,5	108	-	1	38,45
26TA108	108	75	129	-	1	48,03

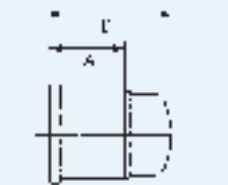

CURVA DE AJUSTE 15°



26CA1528	28	67	134	48	3	6,27
26CA1535	35	78	222	53	3	9,47
26CA1542	42	121	280	59	3	14,73
26CA1554	54	140	337	67	3	18,12



CURVA DE AJUSTE 30°



26CA3028	28	70	130	54	3	6,60
26CA3035	35	86	214	60	3	9,48
26CA3042	42	135	265	69	3	14,82
26CA3054	54	136	326	79	3	18,14



CURVA DE AJUSTE 60°



26CA6028	28	80	125	66	5	6,67
26CA6035	35	105	190	77	5	9,49
26CA6042	42	150	250	90	3	14,53
26CA6054	54	165	306	107	3	18,17

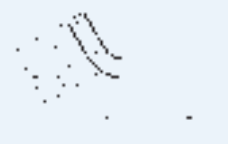

ACCESORIOS FILPRESS (ACERO INOXIDABLE AISI-316)_

FILPRESS PRESSFITTINGS (STAINLESS STEEL AISI-316)_ FILPRESS RACCORDS À SERTIR (ACIER INOXYDABLE AISI-316)_
FILPRESS PRESSFITTINGS (ROSTFREIEM EDELSTAHL AISI-316)

REF.	Ø	A	B	C	PIEZAS/ BOLSA PIECES/ BAG PIÈCES/ SACHETS STÜCKE/ BEUTEL	€/Ud.
------	---	---	---	---	---	-------

CURVA DE AJUSTE 90°

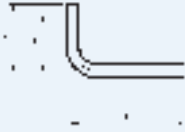
	26CA9015	15	75	122	58	10	3,76	
	26CA9018	18	74	120	63	10	3,64	
	26CA9022	22	77	120	70	10	4,53	
	26CA9028	28	102	120	80	5	6,39	
	26CA9035	35	130	200	100	3	9,54	
	26CA9042	42	185	250	120	2	14,67	
	26CA9054	54	207	300	145	2	18,27	

JUNTA VITON VERDE

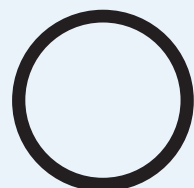
	26JVFKM15	15	-	-	-	25	0,27	
	26JVFKM18	18	-	-	-	25	0,33	
	26JVFKM22	22	-	-	-	25	0,49	
	26JVFKM28	28	-	-	-	25	0,61	
	26JVFKM35	35	-	-	-	25	0,83	
	26JVFKM42	42	-	-	-	10	1,61	
	26JVFKM54	54	-	-	-	10	1,88	
	26JVFKM76	76,1	-	-	-	1	7,76	
	26JVFKM88	88,9	-	-	-	1	9,96	
	26JVFKM108	108	-	-	-	1	18,77	

JUNTA EPDM

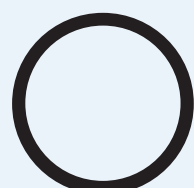
	26JN15	15	-	-	-	25	0,08	
	26JN18	18	-	-	-	25	0,09	
	26JN22	22	-	-	-	25	0,13	
	26JN28	28	-	-	-	25	0,22	
	26JN35	35	-	-	-	25	0,27	
	26JN42	42	-	-	-	10	0,33	
	26JN54	54	-	-	-	10	0,69	
	26JN76	76,1	-	-	-	1	1,59	
	26JN88	88,9	-	-	-	1	1,90	
	26JN108	108	-	-	-	1	4,77	

ACCESORIOS FILPRESS (ACERO INOXIDABLE AISI-316)_

FILPRESS PRESSFITTINGS (STAINLESS STEEL AISI-316)_ FILPRESS RACCORDS À SERTIR (ACIER INOXYDABLE AISI-316)_
 FILPRESS PRESSFITTINGS (ROSTFREIEM EDELSTAHL AISI-316)

REF.	Ø	A	B	C	PIEZAS/ BOLSA PIECES/ BAG PIECES/ SACHETS STÜCKE/ BEUTEL	€/Ud.
------	---	---	---	---	---	-------

TENAZAS PRENSADORAS FILPRESS



26TZ15	15	-	-	-	1	146,39
26TZ18	18	-	-	-	1	146,39
26TZ22	22	-	-	-	1	146,39
26TZ28	28	-	-	-	1	157,02
26TZ35	35	-	-	-	1	181,19
26TZ42	42	-	-	-	1	402,63
26TZ54	54	-	-	-	1	402,63

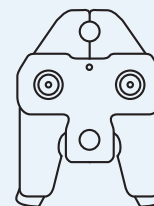

LAZOS PRENSAR Y ADAPTADORES MOD. UAP100



26TZ76	76,1	-	-	-	1	*
26TZ88	88,9	-	-	-	1	*
26TZ108	108	-	-	-	1	*

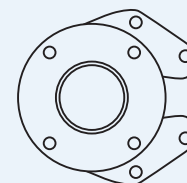

ACCESORIOS FILPRESS (ACERO INOXIDABLE AISI-316)_

FILPRESS PRESSFITTINGS (STAINLESS STEEL AISI-316)_ FILPRESS RACCORDS À SERTIR (ACIER INOXYDABLE AISI-316)_
FILPRESS PRESSFITTINGS (ROSTFREIEM EDELSTAHL AISI-316)

REF.	DESCRIPCIÓN DESCRIPTION DESCRIPTION BESCHREIBUNG	€/Ud.
LAZO PRENSAR REMS (PR) 42 - 54		
26LZ42	Lazo 42 Plier 42 Pince 42 Pressbacke 42	*
26LZ54	Lazo 54 Plier 54 Pince 54 Pressbacke 54	*
26AZ3	Adaptador Z3 Adapter Z3 Adaptateurz3 Stück Z3	*
26CMM42M54Z3	Caja metálica M42-M54-Z3 Metal box M42-M54-Z3 Boite métallique M42-M54-Z3 Metallene Kiste M42-M54-Z3	*

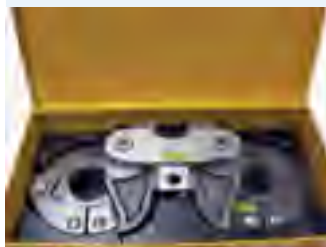

LAZOS PRENSAR Y ADAPTADORES MOD. EC0301

	26TZN76	Ø76,1	*	
	26TZN88	Ø88,9	*	
	26TZN108	Ø108	*	
	26A321	Ø76,1-88-108	*	
	26A322	Ø108	*	

MÁQUINAS PRENSAR

UAP2	Bateria_Battery_Batterie_Batterie: 15-18-22-28-35-42-54	*
UNP2	Eléctrica_Electric_Electrique_Elektrische: 15-18-22-28-35-42-54	*
UAP100	76-88-108	*
EC0301	76-88-108	*
POWER-PRESS	Eléctrica_Electric_Electrique_Elektrische: 15-18-22-28-35-42-54	*
AKKU-PRESS	Bateria_Battery_Batterie_Batterie: 15-18-22-28-35-42-54	*



ACCESORIOS ACERO AL CARBONO
STEEL PRESSFITTINGS_RACCORDS À SERTIR EN ACIER_STAHL PRESSFITTINGS

ACC. ACERO AL CARBONO
PRESSFITTINGS
RACCORDS À SERTIR
PRESSFITTINGS

C2

TUBERÍA ACERO AL CARBONO

STEEL TUBES_TUBES EN ACIER_STAHL ROHRE

Ø x ESPESOR Ø x THICKNESS Ø x ÉPaisseur Ø x DICKE	TUBO PIPE TUBE STANDARD	PESO WEIGHT POID GEWICHT	PRESIÓN DE TRABAJO WORKING PRESSURE PRESSION DE SERVICE ARBEITSDRUCK	€/Ud.
--	----------------------------------	-----------------------------------	---	-------

TUBO GALVANIZADO (INT/EXT) EN 10.305-3



MM.	REF.	(+/-) KG/M	KG/CM	M/PAQUETE	€/Ud.
12x1,2	F03001000	0,416	160	624	*
15x1,2	F03001010	0,408	147	1.836	*
18x1,2	F03001025	0,497	127	1.524	*
22x1,2	F03001030	0,616	98	1.290	*
28x1,5	F03001050	0,980	76	960	*
35x1,5	F03001070	1,239	75	366	*
42x1,5	F03001090	1,498	65	366	*
54x1,5	F03001110	1,942	50	366	*
76,1x2	F03001150	3,655	46	222	*
88,9x2	F03001170	4,286	40	114	*
108x2	F03001190	5,228	33	60	*

TUBO GALVANIZADO (1 CARA EXTERIOR) EN 10.305-3



MM.	REF.	(+/-) KG/M	KG/CM	M/PAQUETE	€/Ud.
12x1,2	3001000	0,416	160	624	*
15x1,2	3001010	0,408	147	1.836	*
18x1,2	3001025	0,497	127	1.524	*
22x1,2	3001030	0,616	98	1.290	*
28x1,5	3001050	0,980	76	960	*
35x1,5	3001070	1,239	75	366	*
42x1,5	3001090	1,498	65	366	*
54x1,5	3001110	1,942	50	366	*
76,1x2	3001150	3,655	46	222	*
88,9x2	3001170	4,286	40	114	*
108x2	3001190	5,228	33	60	*

Produced according to the EN 10.305-3 norm - Price in Euros/Meters - Standard length 6 meter._Produit selon EN 10.305-3 - Prix en Euro/Metre - Longueur Standard de 6 metres._Produziert gemäss EN 10.305-3 . lorm - Preis in Euros / mtr - Standard länge 6 mtr.

ACCESORIOS ACERO AL CARBONO_

STEEL PRESSFITTINGS_ RACCORDS À SERTIR EN ACIER_ STAHL PRESSFITTINGS

REF.	Ø	A	B	PIEZAS/ BOLSA PIECES/ BAG PIÈCES/ SACHETS STÜCKE/ BEUTEL	UNID./ CAJA UNITS/ BOX PIÈCES/ BOITE EINHEITEN/ KASTEN	€/Ud.
------	---	---	---	---	---	-------

CURVA 90° HH

	07450297	12x12	42	-	10	120	2,35
	07450300	15x15	49	-	10	100	2,38
	07450302	18x18	53	-	10	80	2,70
	07450305	22x22	62	-	10	50	2,94
	07450310	28x28	68	-	10	30	3,71
	07450315	35x35	76	-	4	12	7,08
	07450320	42x42	80	-	2	8	12,11
	07450325	54x54	138	-	2	6	14,42
	07450330	76,1x76,1	162	-	1	-	29,55
	07450335	88,9x88,9	215	-	1	-	38,33
07450340	108x108	266	-	1	-	67,25	



CURVA 90° HM

	07450468	12x12	42	46	10	140	2,08
	07450350	15x15	49	57	10	120	2,22
	07450470	18x18	53	61	10	80	2,53
	07450355	22x22	62	68	10	50	2,77
	07450360	28x28	60	67	10	30	3,49
	07450365	35x35	89	100	4	12	6,95
	07450370	42x42	103	129	2	8	12,11
	07450375	54x54	105	115	1	6	14,21
	07450476	76,1x76,1	127	178	1	-	27,12
	07450477	88,9x88,9	180	191	1	-	42,04
07450478	108x108	266	294	1	-	54,24	



CURVA 45° HH

	07450520	12x12	32	-	10	150	2,53
	07450525	15x15	36	-	10	120	2,49
	07450527	18x18	37	-	10	100	2,65
	07450530	22x22	42	-	10	60	2,82
	07450535	28x28	43	-	10	30	3,79
	07450540	35x35	56	-	4	20	6,84
	07450545	42x42	54	-	2	12	8,74
	07450550	54x54	74	-	2	6	10,21
	07450555	76,1x76,1	120	-	1	-	26,12
	07450560	88,9x88,9	133	-	1	-	37,53
07450565	108x108	152	-	1	-	54,00	

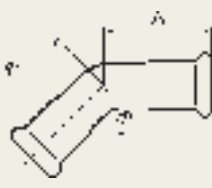

CURVA DOS PIEZAS

	07450481	1/2x15	-	-	10	40	-
	07450483	1/2x18	-	-	10	40	-
	07450484	3/4x18	-	-	10	40	-
	07450486	3/4x22	-	-	10	30	-
	07450487	1x22	-	-	10	20	-

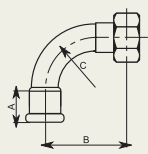

ACC. ACERO AL CARBONO
PRESSFITTINGS
RACCORDS À SERTIR
PRESSFITTINGS

C2

ACCESORIOS ACERO AL CARBONO

STEEL PRESSFITTINGS_RACCORDS À SERTIR EN ACIER_STAHL PRESSFITTINGS

REF.	Ø	A	B	PIEZAS/ BOLSA PIECES/ BAG PIÈCES/ SACHETS STÜCKE/ BEUTEL	UNID./ CAJA UNITS/ BOX PIÈCES/ BOITE EINHEITEN/ KASTEN	€/Ud.
------	---	---	---	---	---	-------

CURVA 45° HM

	07450570	12x12	34	40	10	150	2,40
	07450575	15x15	36	38	10	120	2,26
	07450577	18x18	39	42	10	100	2,49
	07450580	22x22	46	49	10	60	2,67
	07450585	28x28	47	46	10	30	3,58
	07450590	35x35	59	63	4	20	6,53
	07450595	42x42	65	64	2	16	8,63
	07450600	54x54	67	66	2	6	10,11
	07450605	76,1x76,1	145	143	1	-	26,16
	07450610	88,9x88,9	151	151	1	-	38,09
	07450615	108x108	174	190	1	-	49,71

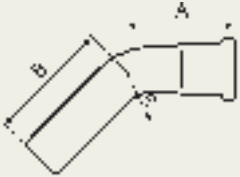

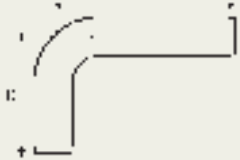

CURVA DE AJUSTE 90

	07450479	12x12	120	70	10	70	2,02
	07450480	15x15	120	70	10	60	2,02
	07450482	18x18	120	70	10	50	2,05
	07450485	22x22	120	70	10	40	2,27
	07450490	28x28	120	80	4	20	2,80
	07450495	35x35	207	122	2	6	6,93
	07450500	42x42	255	152	1	2	10,83
	07450505	54x54	310	198	1	2	13,72



MANGUITO HH

	07450000	12x12	47	-	10	180	1,35
	07450005	15x15	57	-	10	150	1,47
	07450007	18x18	53	-	10	120	1,54
	07450010	22x22	55	-	10	80	1,69
	07450015	28x28	59	-	10	50	2,09
	07450020	35x35	63	-	4	28	3,24
	07450025	42x42	76	-	2	20	4,40
	07450030	54x54	86	-	2	12	5,24
	07450035	76,1x76,1	146	-	1	-	16,82
	07450040	88,9x88,9	164	-	1	-	20,14
	07450045	108x108	205	-	1	-	29,72



MANGUITO COMPRESIÓN

	07451150	15x15	61	-	10	80	5,39
	07451155	22x22	65	-	10	50	7,81
	07451160	28x28	67	-	10	40	10,43

Posibilidad de adaptación a tubería de más diámetro con el tubo de transición.

ACCESORIOS ACERO AL CARBONO_

STEEL PRESSFITTINGS_ RACCORDS À SERTIR EN ACIER_ STAHL PRESSFITTINGS

REF.	Ø	A	B	PIEZAS/ BOLSA PIECES/ BAG PIÈCES/ SACHETS STÜCKE/ BEUTEL	UNID./ CAJA UNITS/ BOX PIÈCES/ BOITE EINHEITEN/ KASTEN	€/Ud.
------	---	---	---	---	---	-------

MANGUITO SIN TOPE



07450220	12x12	56	-	10	180	1,66
07450225	15x15	73	-	10	120	1,84
07450227	18x18	80	-	10	70	2,37
07450230	22x22	84	-	10	50	2,45
07450235	28x28	92	-	10	30	3,18
07450240	35x35	99	-	10	20	5,58
07450245	42x42	115	-	4	12	6,29
07450250	54x54	138	-	4	8	7,40
07450255	76,1x76,1	224	-	1	-	28,22
07450260	88,9x88,9	263	-	1	-	36,88
07450265	108x108	313	-	1	-	39,31

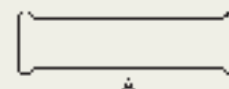

TE IGUAL



07450620	12x12x12	56	26	10	100	3,94
07450625	15x15x15	63	39	10	80	4,32
07450627	18x18x18	68	44	10	60	4,63
07450630	22x22x22	74	46	10	40	4,82
07450635	28x28x28	84	51	4	24	5,89
07450640	35x35x35	102	57	2	12	9,26
07450645	42x42x42	65	65	2	8	12,63
07450650	54x54x54	145	75	1	4	15,68
07450655	76,1x76,1x76,1	230	113	1	-	59,36
07450660	88,9x88,9x88,9	260	128	1	-	68,02
07450665	108x108x108	310	150	1	-	88,34

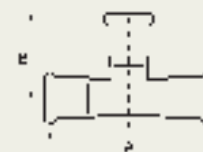

TE REDUCIDA EN EXTREMOS



07450670	12x15x12	56	39	10	80	4,09
07450672	15x18x15	74	37	10	60	6,28
07450675	15x22x15	74	43	10	50	6,57
07450708	18x22x18	68	42	10	50	4,27
07450685	22x28x22	84	57	10	30	7,02

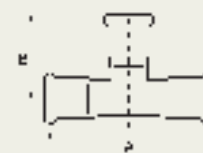

TE REDUCIDA



07450690	22x15x15	-	-	10	40	7,33
07450695	22x22x15	-	-	10	40	6,32
07450700	28x22x22	-	-	5	20	7,76
07450705	28x28x22	-	-	5	20	8,03

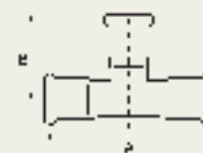

ACC. ACERO AL CARBONO
PRESSFITTINGS
RACCORDS À SERTIR
PRESSFITTINGS

C2

ACCESORIOS ACERO AL CARBONO

STEEL PRESSFITTINGS_RACCORDS À SERTIR EN ACIER_STAHL PRESSFITTINGS

REF.	Ø	A	B	PIEZAS/ BOLSA PIECES/ BAG PIÈCES/ SACHETS STÜCKE/ BEUTEL	UNID./ CAJA UNITS/ BOX PIÈCES/ BOITE EINHEITEN/ KASTEN	€/Ud.
------	---	---	---	---	---	-------

TE REDUCIDA



07450671	15x12x15	64	37	10	70	3,72
07450706	18x12x18	68	39	10	60	4,06
07450707	18x15x18	68	42	10	60	4,32
07450709	22x12x22	74	42	10	40	4,33
07450710	22x15x22	74	44	10	40	5,36
07450712	22x18x22	74	44	10	40	4,65
07450715	28x15x28	84	47	10	30	5,68
07450717	28x18x28	84	47	10	30	5,84
07450720	28x22x28	84	49	10	30	6,26
07450725	35x15x35	100	51	4	20	8,32
07450727	35x18x35	100	51	4	16	8,68
07450730	35x22x35	100	53	4	16	8,95
07450735	35x28x35	100	55	4	16	9,11
07450740	42x22x42	114	56	4	12	11,84
07450745	42x28x42	114	58	4	12	12,11
07450750	42x35x42	114	61	2	10	12,11
07450755	54x22x54	138	62	1	6	13,68
07450760	54x28x54	138	64	1	6	14,21
07450765	54x35x54	138	67	1	6	14,68
07450770	54x42x54	138	71	1	6	15,00
07450775	76,1x54x76,1	230	120	1	-	45,41
07450780	88,9x76,1x88,9	260	128	1	-	64,95
07450785	108x88,9x108	310	153	1	-	79,21

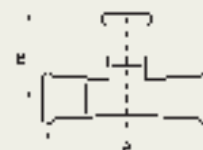

TE ROSCADA



07450800	15x1/2x15	64	35	10	60	6,67
07450802	18x1/2x18	68	37	10	50	6,82
07450806	18x3/4x18	-	-	10	40	-
07450805	22x1/2x22	74	39	10	40	6,82
07450824	22x3/4x22	74	42	10	40	8,32
07450810	28x1/2x28	84	42	10	30	7,03
07450826	28x3/4x28	84	45	4	28	8,02
07450815	35x1/2x35	100	46	4	16	9,09
07450827	35x3/4x35	100	50	2	14	12,00
07450820	42x1/2x42	114	49	2	10	13,64
07450828	42x3/4x42	114	53	1	8	13,64
07450825	54x1/2x54	138	55	1	6	14,64
07450841	54x2x54	-	-	1	1	-
07450829	54x3/4x54	138	60	1	6	15,31
07450830	76,1x3/4x76,1	230	78	1	-	44,61
07450842	76,1x2x76,1	-	-	1	-	-
07450835	88,9x3/4x88,9	260	78	1	-	47,23
07450843	88,9x2x88,9	-	-	1	-	-
07450840	108x3/4x108	310	85	1	-	70,56
07450844	108x2x108	-	-	1	-	-



ACCESORIOS ACERO AL CARBONO_

STEEL PRESSFITTINGS_ RACCORDS À SERTIR EN ACIER_ STAHL PRESSFITTINGS

REF.	Ø	A	B	PIEZAS/ BOLSA PIECES/ BAG PIÈCES/ SACHETS STÜCKE/ BEUTEL	UNID./ CAJA UNITS/ BOX PIÈCES/ BOITE EINHEITEN/ KASTEN	€/Ud.
------	---	---	---	---	---	-------

UNIÓN MACHO



07450050	3/8"x12	31	-	10	180	3,34
07450055	3/8"x15	35	-	10	150	3,74
07450060	1/2"x15	39	-	10	150	3,74
07450057	1/2"x18	39	-	10	120	4,11
07450065	1/2"x22	44	-	10	100	5,21
07450070	3/4"x15	40	-	10	100	5,05
07450072	3/4"x18	40	-	10	100	5,05
07450075	3/4"x22	44	-	10	90	5,00
07450080	3/4"x28	44	-	10	50	6,03
07450085	1"x22	44	-	10	50	5,91
07450090	1"x28	44	-	10	50	6,05
07450095	1"x35	49	-	10	28	8,68
07450100	1 1/4"x35	52	-	4	28	8,75
07450105	1 1/4"x42	59	-	4	24	11,55
07450110	1 1/2"x42	59	-	4	24	10,74
07450115	2"x54	69	-	2	10	16,32
07450120	2 1/2"x76	-	-	1	-	55,64
07450125	3"x88,9	-	-	1	-	72,06

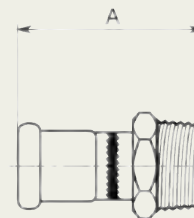

UNIÓN HEMBRA



07450145	1/2"x12	40	-	10	120	3,51
07450150	1/2"x15	41	-	10	120	4,00
07450152	1/2"x18	43	-	10	120	4,42
07450155	1/2"x22	43	-	10	100	5,00
07450157	3/4"x18	43	-	10	80	5,37
07450160	3/4"x22	43	-	10	80	5,37
07450165	1"x22	50	-	10	50	6,25
07450170	1"x28	50	-	10	50	6,45
07450175	5/4"x35	56	-	4	20	8,66
07450180	1 1/2"x42	-	-	1	-	15,33
07450185	2"x54	-	-	1	-	21,45

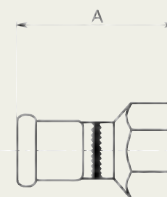

REDUCCIÓN HH



07450200	22x15	47	-	10	100	3,42
07450205	28x15	59	-	10	60	4,16
07450210	28x22	63	-	10	50	4,54
07450215	35x28	55	-	4	24	7,48

BRIDA ADAPTADOR



07450934	42	-	-	1	-	-
07450936	54	-	-	1	-	-
07450937	76,1	PN16	-	1	-	97,44
07450938	88,9	PN16	-	1	-	115,61
07450939	108	PN16	-	1	-	132,57



ACC. ACERO AL CARBONO
PRESSFITTINGS
RACCORDS À SERTIR
PRESSFITTINGS

C2

ACCESORIOS ACERO AL CARBONO

STEEL PRESSFITTINGS_RACCORDS À SERTIR EN ACIER_STAHL PRESSFITTINGS

REF.	Ø	A	B	PIEZAS/ BOLSA PIECES/ BAG PIÈCES/ SACHETS STÜCKE/ BEUTEL	UNID./ CAJA UNITS/ BOX PIÈCES/ BOITE EINHEITEN/ KASTEN	€/Ud.
------	---	---	---	---	---	-------

RACOR 2 PIEZAS

	07450266	1/2"x15	-	-	10	120	-
	07450267	1/2"x18	-	-	10	100	-
	07450270	3/4"x15	37	-	10	120	6,34
	07450272	3/4"x18	37	-	10	100	6,41
	07450273	3/4"x22	-	-	10	60	-
	07450275	1"x22	40	-	10	60	7,65
	07450276	1"x28	-	-	4	40	-
	07450280	1 1/4"x28	44	-	4	40	9,91
	07450283	1 1/4"x35	-	-	4	24	-
	07450285	1 1/2"x35	48	-	4	24	13,28
	07450287	1 1/2"x42	-	-	4	20	-
	07450290	1 3/4"x42	-	-	4	20	19,40
	07450293	2"x54	-	-	2	10	-
	07450295	2 3/8"x54	-	-	2	10	26,01
	07450296	2 1/2"x76	-	-	2	10	-

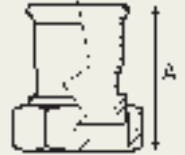

CURVA MACHO

	07450395	3/8"x12	47	-	10	100	6,29
	07450400	3/8"x15	49	-	10	100	5,86
	07450405	1/2"x15	49	-	10	80	6,16
	07450407	1/2"x18	53	-	10	70	6,44
	07450408	1/2"x22	-	-	10	40	6,95
	07450410	3/4"x22	62	-	10	40	7,92
	07450415	1"x28	68	-	4	20	9,67
	07450420	1 1/4"x35	76	-	4	12	14,27
	07450425	1 1/2"x42	80	-	2	8	23,37
	07450430	2"x54	100	-	1	4	31,05

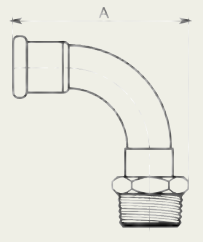

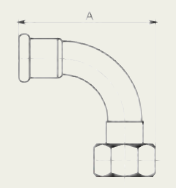

CURVA HEMBRA

	07450450	1/2"x15	49	-	10	80	6,22
	07450452	1/2"x18	53	-	10	60	6,52
	07450453	1/2"x22	-	-	10	40	7,00
	07450455	3/4"x22	62	-	10	40	7,98
	07450460	1"x28	68	-	4	20	10,08
	07450465	1 1/4"x35	76	-	4	12	13,99



CODO MACHO ESCUADRA

	07450850	3/8"x15	38	22	10	80	6,95
	07450855	1/2"x15	39	28	10	80	7,37
	07450857	1/2"x18	39	28	10	80	7,71
	07450860	3/4"x22	43	32	10	50	8,72



CODO MACHO

	07450467	1/2"x15	-	-	10	75	6,95
	07450469	1/2"x18	-	-	10	75	7,37
	07450471	3/4"x22	-	-	10	40	7,71

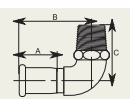

ACCESORIOS ACERO AL CARBONO

STEEL PRESSFITTINGS_RACCORDS À SERTIR EN ACIER_STAHL PRESSFITTINGS

REF.	Ø	A	B	PIEZAS/ BOLSA PIECES/ BAG PIÈCES/ SACHETS STÜCKE/ BEUTEL	UNID./ CAJA UNITS/ BOX PIÈCES/ BOITE EINHEITEN/ KASTEN	€/Ud.
------	---	---	---	---	---	-------

ADAPTADOR HEMBRA



07450870	1/2"x12	58	-	10	120	2,43
07450875	1/2"x15	61	-	10	100	2,53
07450877	1/2"x18	61	-	10	100	2,63
07450882	3/4"x18	64	-	10	80	4,23
07450880	1/2"x22	62	-	10	100	3,16
07450885	3/4"x22	65	-	10	80	4,45

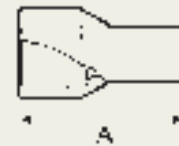

ADAPTADOR MACHO



07450900	1/2"x15	57	-	10	120	2,43
07450902	1/2"x18	59	-	10	150	2,52
07450905	3/4"x15	57	-	10	100	3,63
07450907	3/4"x18	59	-	10	100	3,69
07450910	3/4"x22	59	-	10	90	3,94



SALTATUBOS



07450920	12x12	154	35	10	80	2,66
07450925	15x15	158	37	10	60	2,84
07450927	18x18	165	40	10	60	3,16
07450930	22x22	178	44	10	40	3,68
07450935	28x28	210	50	4	16	4,21



CRUZ REDUCIDA

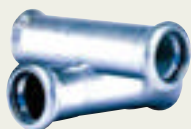

07450950	15x15x15x15	80	80	10	40	9,88
07450956	18x15x18x15	80	80	10	40	9,88
07450955	22x15x22x15	84	80	10	30	9,87
07450957	22x18x22x18	84	80	10	30	9,87
07450960	28x18x28x18	-	-	2	10	-
07450961	42x28x42x28	-	-	1	5	-
07450958	76,1x28x76,1x28	-	-	1	-	-
07450959	88,9x28x88,9x28	-	-	1	-	-

TAPÓN



07450975	15	26	-	20	300	2,74
07450977	18	27	-	20	240	3,05
07450980	22	29	-	10	150	3,37
07450985	28	33	-	10	80	3,89
07450990	35	37	-	4	60	4,68
07450995	42	43	-	4	20	7,36
07451000	54	52	-	2	16	8,53
07451005	76,1	70	-	1	-	22,80
07451010	88,9	80	-	1	-	28,25
07451015	108	100	-	1	-	43,86



ACC. ACERO AL CARBONO
PRESSFITTINGS
RACCORDS À SERTIR
PRESSFITTINGS

C2

ACCESORIOS ACERO AL CARBONO

STEEL PRESSFITTINGS_RACCORDS À SERTIR EN ACIER_STAHL PRESSFITTINGS

REF.	Ø	A	B	PIEZAS/ BOLSA PIECES/ BAG PIÈCES/ SACHETS STÜCKE/ BEUTEL	UNID./ CAJA UNITS/ BOX PIÈCES/ BOITE EINHEITEN/ KASTEN	€/Ud.
------	---	---	---	---	---	-------

REDUCCIÓN MH

07451055	15x12	51	-	10	200	1,76
07451060	18x12	53	-	10	160	1,78
07451065	18x15	55	-	10	160	1,84
07451070	22x12	60	-	10	120	2,03
07451075	22x15	59	-	10	120	1,89
07451077	22x18	57	-	10	100	2,00
07451080	28x15	66	-	10	90	2,53
07451082	28x18	64	-	10	80	2,63
07451085	28x22	60	-	10	60	2,53
07451090	35x15	81	-	5	40	5,92
07451092	35x18	85	-	5	40	6,10
07451095	35x22	71	-	10	40	4,10
07451100	35x28	68	-	4	36	2,95
07451105	42x22	98	-	4	32	8,60
07451110	42x28	99	-	4	24	7,12
07451115	42x35	77	-	4	24	5,56
07451120	54x22	95	-	2	16	15,68
07451125	54x28	110	-	2	14	8,66
07451130	54x35	117	-	2	14	8,66
07451135	54x42	92	-	2	12	6,42
07451137	76,1x42	148	-	1	-	26,64
07451139	76,1x54	146	-	1	-	28,17
07451141	88,9x54	163	-	1	-	31,11
07451143	88,9x76,1	161	-	1	-	35,87
07451145	108x76,1	184	-	1	-	40,48
07451147	108x88,9	203	-	1	-	49,10

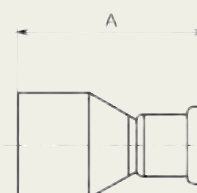

TENAZAS PRENSADORAS INSTALPRESS PERFIL M

27TZ12	12	-	-	-	-	140,64
27TZ15	15	-	-	-	-	140,64
27TZ18	18	-	-	-	-	140,64
27TZ22	22	-	-	-	-	140,64
27TZ28	28	-	-	-	-	150,85
27TZ35	35	-	-	-	-	174,07
27TZ42	42	-	-	-	-	386,81
27TZ54	54	-	-	-	-	386,81
27TZN76	76,1	-	-	-	-	*
27TZN88	88,9	-	-	-	-	*
26TZN108	108	-	-	-	-	*
26A321	76,1-88-108	-	-	-	-	*
26A322	108	-	-	-	-	*





ACCESORIOS CAPILARES

CAPILLARY FITTINGS_ ACCESSOIRES CAPILLAIRES_ KAPILLARITÄTS ZUBEHÖR

ACCESORIOS CAPILARES
CAPILLARY FITTINGS
ACCESSOIRES CAPILLAIRES
KAPILLARITÄTS ZUBEHÖR

C3

ACCESORIOS CAPILARES (ACERO INOXIDABLE AISI-316)_

CAPILLARY FITTINGS (STAINLESS STEEL AISI-316)_ ACCESSOIRES CAPILLAIRES (ACIER INOXYDABLE AISI-316)_
KAPILLARITÄTS-ZUBEHÖR (ROSTFREIEM EDELSTÄHL AISI-316)

REF.	Ø	A	B	C	PIEZAS/ BOLSA PIECES/ BAG PIÈCES/ SACHETS STÜCKE/ BEUTEL	€/Ud.
------	---	---	---	---	---	-------

CURVA 90° HH



204C90HH10	10	9	30,5	20	25	4,79
204C90HH12	12	10	35,5	24	25	4,31
204C90HH15	15	12	41,5	28	25	4,43
204C90HH18	18	14	47,5	32	25	4,82
204C90HH22	22	17	56,5	38	15	5,22
204C90HH28	28	20	72	50	5	6,45
204C90HH35	35	25	95	68	5	10,96
204C90HH42	42	29	112	80	5	15,75

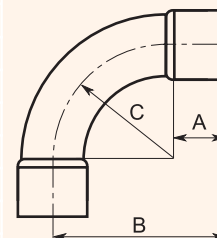

CURVA 90° HM



204C90HM10	10	9	31	20	25	4,95
204C90HM12	12	10	36	24	25	4,43
204C90HM15	15	12	42	28	25	4,67
204C90HM18	18	14	48	32	25	5,46
204C90HM22	22	17	57	38	15	5,74
204C90HM28	28	20	72	50	5	7,04
204C90HM35	35	25	95	68	5	11,47
204C90HM42	42	29	111	80	5	16,35

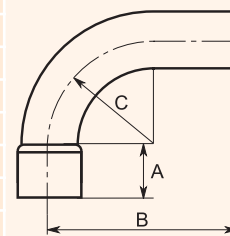

CURVA 45° HH



204C45HH10	10	9	19	20	25	4,46
204C45HH12	12	10	28	24	25	4,04
204C45HH15	15	12	30	28	25	4,16
204C45HH18	18	14	33	32	25	4,50
204C45HH22	22	17	38	38	25	4,82
204C45HH28	28	20	48	50	10	5,94
204C45HH35	35	25	65	68	10	8,86
204C45HH42	42	29	77	80	5	11,84

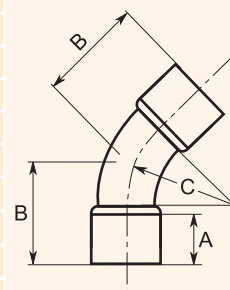

CURVA 45° HM



204C45HM10	10	9	19	20	25	3,99
204C45HM12	12	10	28	24	25	4,23
204C45HM15	15	12	30	28	25	4,20
204C45HM18	18	14	33	32	25	4,63
204C45HM22	22	17	38	38	25	5,22
204C45HM28	28	20	48	50	10	5,96
204C45HM35	35	25	65	68	10	9,61
204C45HM42	42	29	77	80	5	11,73

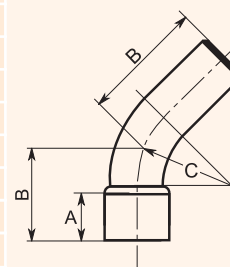

ACCESORIOS CAPILARES (ACERO INOXIDABLE AISI-316)

CAPILLARY FITTINGS (STAINLESS STEEL AISI-316)_ ACCESSOIRES CAPILLAIRES (ACIER INOXYDABLE AISI-316)_
KAPILLARITÄTS-ZUBEHÖR (ROSTFREIEM EDELSTAHL AISI-316)

REF.	Ø	A	B	C	PIEZAS/ BOLSA PIECES/ BAG PIÈCES/ SACHETS STÜCKE/ BEUTEL	€/Ud.
------	---	---	---	---	---	-------

MANGUITO HH



204M10	10	9	24	-	25	1,64
204M12	12	10	26	-	25	1,44
204M15	15	12	30	-	25	1,48
204M18	18	14	34	-	25	1,68
204M22	22	17	40	-	25	1,80
204M28	28	20	46	-	10	2,34
204M35	35	25	56	-	10	3,69
204M42	42	29	64	-	10	4,82

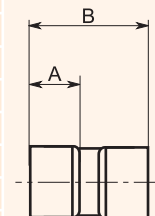

TE IGUAL HHH



204T10	10	9	38	19	25	7,57
204T12	12	10	42	21	25	6,81
204T15	15	12	49	24,5	25	6,14
204T18	18	14	56	28	25	6,69
204T22	22	17	66	33	15	7,68
204T28	28	20	80	40	5	9,27
204T35	35	25	99	49,5	5	15,12
204T42	42	29	114	57	5	15,92

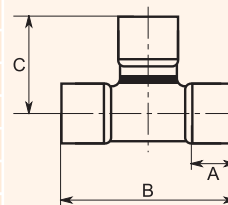

TE REDUCCIÓN



204TR15X12	15X12	12	49	22,5	25	6,25
204TR18X12	18X12	14	56	24	25	6,54
204TR18X15	18X15	14	56	26	25	6,57
204TR22X12	22X12	17	66	26	15	7,58
204TR22X15	22X15	17	66	28	15	7,09
204TR22X18	22X18	17	66	30	15	7,58
204TR28X15	28X15	17	80	31	5	7,09
204TR28X18	28X18	20	80	33,5	5	7,57
204TR28X22	28X22	20	80	37	5	7,86
204TR35X15	35X15	20	65	33	5	9,90
204TR35X18	35X18	25	65	35	5	10,12
204TR35X22	35X22	25	65	36,5	5	14,84
204TR35X28	35X28	25	99	43,5	5	15,03
204TR42X15	42X15	29	86	37	5	14,83
204TR42X18	42X18	29	86	39	4	15,57
204TR42X22	42X22	29	86	41	4	15,97
204TR42X28	42X28	29	86	44	4	16,48
204TR42X35	42X35	29	86	41	4	17,50

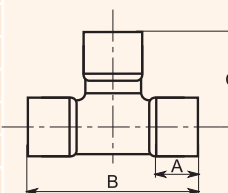

ACCESORIOS CAPILARES
CAPILLARY FITTINGS
ACCESSOIRES CAPILLAIRES
KAPILLARITÄTS ZUBEHÖR

C3

ACCESORIOS CAPILARES (ACERO INOXIDABLE AISI-316)_

CAPILLARY FITTINGS (STAINLESS STEEL AISI-316)_ ACCESSOIRES CAPILLAIRES (ACIER INOXYDABLE AISI-316)_
KAPILLARITÄTS-ZUBEHÖR (ROSTFREIEM EDELSTÄHL AISI-316)

REF.	Ø	A	B	C	PIEZAS/ BOLSA PIECES/ BAG PIÈCES/ SACHETS STÜCKE/ BEUTEL	€/Ud.
------	---	---	---	---	---	-------

REDUCCIÓN MH



204RE12X10	12X10	10	25	9	25	1,46
204RE15X10	15X10	-	-	-	25	1,50
204RE15X12	15X12	13	37	11	25	1,58
204RE18X12	18X12	15	40	11	25	1,86
204RE18X15	18X15	15	40	13	25	2,03
204RE22X12	22X12	18	44	11	25	1,85
204RE22X15	22X15	18	49	13	25	1,90
204RE22X18	22X18	18	47	13	25	1,95
204RE28X12	28X12	20	40	10	10	2,30
204RE28X15	28X15	20	45	12	10	2,37
204RE28X18	28X18	20	52	14	10	3,16
204RE28X22	28X22	20	59	17	10	3,32
204RE35X28	35X28	27	62	20	10	3,21
204RE42X28	42X28	31	67	20	5	6,09
204RE42X35	42X35	29	70	23	5	6,76

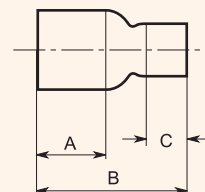

CURVA 2 PIEZAS



204CP12X38	12X3/8"	10	36	24	25	4,42
204CP15X12	15X1/2"	12	38	28	25	5,21
204CP18X34	18X3/4"	14	44	32	15	5,50
204CP22X10	22X1"	17	54	38	10	6,81

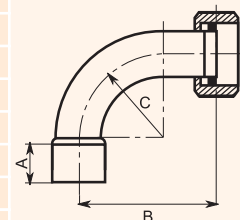

TE ROSCADA H



204TH15X12	15X1/2"	12	49	34	10	15,81
204TH18X12	18X1/2"	14	56	36	10	16,70
204TH22X12	22X1/2"	17	66	38	10	17,67

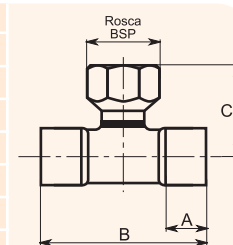

CODO HEMBRA



204CH15X12	15X1/2"	22	25	12	10	7,40
204CH18X12	18X1/2"	22	25	10	10	5,60

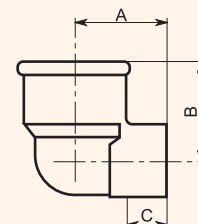

ACCESORIOS CAPILARES (ACERO INOXIDABLE AISI-316)

CAPILLARY FITTINGS (STAINLESS STEEL AISI-316) ACCESOIRES CAPILLAIRES (ACIER INOXYDABLE AISI-316)
KAPILLARITÄTS-ZUBEHÖR (ROSTFREIEM EDELSTÄHL AISI-316)

REF.	Ø	A	B	C	PIEZAS/ BOLSA PIECES/ BAG PIECES/ SACHETS STÜCKE/ BEUTEL	€/Ud.
------	---	---	---	---	---	-------

RACOR 2 PIEZAS



204RP12X38	12X3/8"	33	10	3,5	25	2,53
204RP12X12	12X1/2"	38	10	3,5	25	3,09
204RP15X12	15X1/2"	37	12	3,5	25	3,21
204RP18X12	18X1/2"	36	15	3,5	25	3,60
204RP18X34	18X3/4"	42	15	3,5	25	4,07
204RP18X78	18X7/8"	42	15	3,5	10	4,15
204RP22X34	22X3/4"	41	18	3,5	25	4,63
204RP22X78	22X7/8"	41	18	4	10	5,07
204RP22X10	22X1"	48	18	4	15	5,39
204RP28X10	28X1"	48	22	4	15	5,90
204RP28X114	28X1 1/4"	48	22	4	10	6,68
204RP35X114	35X1 1/4"	51	25	3,5	10	7,60
204RP42X112	42X1 1/2"	61	29	3,5	10	10,34

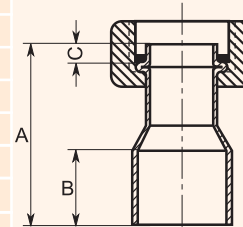

ENLACE MACHO



204EM10X14	10X1/4"	8	19	9	10	6,90
204EM10X38	10X3/8"	8	20	10	10	7,66
204EM12X38	12X3/8"	10	21	10	10	7,94
204EM12X12	12X1/2"	10	23	11	10	8,86
204EM15X12	15X1/2"	11	23	11	10	8,08
204EM18X12	18X1/2"	13	26	11	10	8,27
204EM18X34	18X3/4"	13	28	13	10	11,54
204EM22X34	22X3/4"	16	32	13	10	10,79
204EM22X10	22X1"	16	33	13.5	10	22,52
204EM28X10	28X1"	19	35	13.5	10	21,75
204EM35X114	35X1 1/4"	22	43	16	10	29,35
204EM42X112	42X1 1/2"	24	48	17	10	39,07

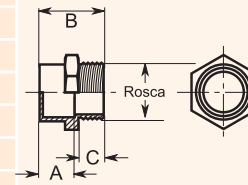

ENLACE HEMBRA



204EH10X14	10X1/4"	8	21	11	10	7,15
204EH10X38	10X3/8"	8	23	13	10	9,04
204EH12X38	12X3/8"	10	24	13	10	8,99
204EH12X12	12X1/2"	10	26	15	10	9,84
204EH15X12	15X1/2"	11	27	15	10	10,11
204EH18X12	18X1/2"	13	29	15	10	10,31
204EH18X34	18X3/4"	13	31	17	10	14,52
204EH22X34	22X3/4"	16	34	17	10	15,06
204EH22X10	22X1"	16	36	18	10	22,93
204EH28X10	28X1"	19	36	18	10	22,25
204EH35X114	35X1 1/4"	22	45	21	10	37,73
204EH42X112	42X1 1/2"	24	50	23	10	47,41

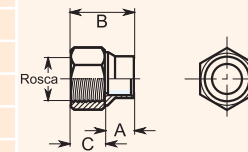

ACCESORIOS CAPILARES
CAPILLARY FITTINGS
ACCESOIRES CAPILLAIRES
KAPILLARITÄTS-ZUBEHÖR

C3

ACCESORIOS CAPILARES (ACERO INOXIDABLE AISI-316)_

CAPILLARY FITTINGS (STAINLESS STEEL AISI-316)_ ACCESSOIRES CAPILLAIRES (ACIER INOXYDABLE AISI-316)_
KAPILLARITÄTS-ZUBEHÖR (ROSTFREIEM EDELSTÄHL AISI-316)

REF.	DESCRIPCIÓN DESCRIPTION BESCHREIBUNG	€/Ud.
------	--	-------

SOLDADURAS Y ACCESORIOS

	90AGCD	Varilla de aportación F-30 AG CD desnuda (250 gr.) <i>Welding rod F-30 AG CD (250gr)</i> <i>Baguette d'apport F-30 AGR (250gr)</i> <i>Schweissdraht F-30 AGR (250gr)</i>	*	
	90AGR	Varilla de aportación F-30 AGR recubierta (250 gr.) <i>Covered welding rod F-30 AGR (250gr)</i> <i>Baguette d'apport enrobée F-30 AGR (250gr)</i> <i>Ummantelter Schweissdraht</i>	*	
	91AGX	Flux polvo AGX - Bote 250 gr. <i>Flux powder AGX 250gr TIN</i> <i>Flux en poudre AGX 250gr TIN</i> <i>Löt Puder AGX 250gr TIN</i>	107,26	
	91AGF	Flux pasta AGF - Bote 250 gr. <i>Flux paste AGF-250gr TIN</i> <i>Flux en pâte AGF 250 gr. TIN</i> <i>Löt Paste AGX 250gr TIN</i>	53,66	
	93DLI	Disco de limpieza (Negro) <i>Cleaning disk (Black)</i> <i>Disque Nettoyant (Noir)</i> <i>Putzscheibe (schwarz)</i>	19,22	
	93DPU	Disco de pulir (Blanco) <i>Cleaning disk (White)</i> <i>Disque Nettoyant (Blanc)</i> <i>Putzscheibe (weiss)</i>	13,09	
	93RPP	Pasta de pulir <i>Polish paste</i> <i>Pâte à polir</i> <i>Poliermittel</i>	5,44	
	92SF50	Sellador FILTUBE 50 ml. <i>FILTUBE adhesive 50 ml.</i> <i>FILTUBE adhésif 50ml.</i> <i>FILTUBE Klebstoff 50ml.</i>	34,88	
	94LF400	Limpiador FILTUBE 400 ml. <i>FILTUBE cleaner 400 ml.</i> <i>FILTUBE nettoyant 400ml.</i> <i>FILTUBE Reinigungsmittel 400ml.</i>	13,31	



ABRAZADERAS FILTUBE
FILTUBE PIPE CLAMPS_ COLLIERS FILTUBE_ FILTUBE ROHRSCHELLEN

ABRAZADERAS FILTUBE
FILTUBE PIPE CLAMPS
COLLIERS FILTUBE
FILTUBE ROHRSCHELLEN

C4

ABRAZADERAS FILTUBE (ACERO INOXIDABLE AISI-304)_

FILTUBE PIPE CLAMPS (STAINLESS STEEL AISI-304)_ COLLIERS FILTUBE (ACIER INOXYDABLE AISI-304)_
 FILTUBE ROHRSCHELLEN (ROSTFREIEM EDELSTAHL AISI-304)

REF.	Ø	A	B	C	UNID./CAJA UNITS/BOX PIÈCES/BOÎTE EINHEITEN/KASTEN	€/Ud.
------	---	---	---	---	---	-------

SIMPLE

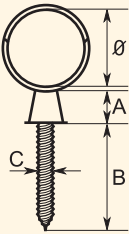
	40AS10	10	7	25	3,9	150	0,33	
	40AS12	12	7	25	3,9	150	0,32	
	40AS15	15	7	35	4,8	90	0,41	
	40AS18	18	7	35	4,8	60	0,48	
	40AS22	22	7	35	4,8	40	0,64	
	40AS28	28	7	35	4,8	20	0,98	
	40AS35	35	9	45	6,3	10	1,70	
	40AS42	42	9	45	6,3	7	2,25	

DOBLE

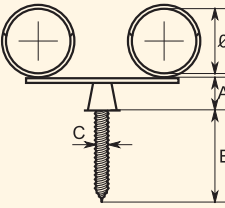
	40AD10	10	8	25	3,9	75	1,55	
	40AD12	12	8	25	3,9	50	1,18	
	40AD15	15	8	35	4,8	30	1,21	
	40AD18	18	8	35	4,8	25	1,38	
	40AD22	22	8	35	4,8	15	1,73	

PLUS

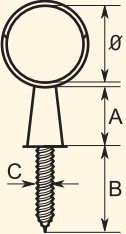
	40AP15	15	13	35	4,8	75	0,59	
	40AP18	18	13	35	4,8	50	0,70	
	40AP22	22	13	35	4,8	30	0,86	
	40AP28	28	13	35	4,8	15	1,28	
	40AP35	35	13	45	6,3	8	1,99	
	40AP42	42	13	45	6,3	5	2,59	

ABRAZADERAS FILTUBE (ACERO INOXIDABLE AISI-304)_

FILTUBE PIPE CLAMPS (STAINLESS STEEL AISI-304)_ COLLIERS FILTUBE (ACIER INOXYDABLE AISI-304)_
 FILTUBE ROHRSCHELLEN (ROSTFREIEM EDELSTAHL AISI-304)

REF.	Ø	A	B	C	UNID./ CAJA UNITS/ BOX PIECES/ BOITE EINHEITEN/ KASTEN	€/Ud.
------	---	---	---	---	---	-------

HEMBRA

	40AH10	10	5	9	10	150	1,06	
	40AH12	12	5	9	10	150	1,14	
	40AH15	15	6	10	12	90	0,95	
	40AH18	18	6	10	12	60	1,05	
	40AH22	22	6	10	12	40	1,19	
	40AH28	28	6	10	12	20	1,48	
	40AH35	35	8	12	15	10	2,44	
	40AH42	42	8	12	15	7	3,00	

MACHO

	40AM10	10	5	12	7	150	0,77	
	40AM12	12	5	12	7	150	0,87	
	40AM15	15	6	12	6	90	0,66	
	40AM18	18	6	12	6	60	0,79	
	40AM22	22	6	12	6	40	0,89	
	40AM28	28	6	12	6	20	1,41	
	40AM35	35	8	16	10	10	1,79	
	40AM42	42	8	16	10	7	2,35	

ABRAZADERAS FILTUBE
 FILTUBE PIPE CLAMPS
 COLLIERS FILTUBE
 FILTUBE ROHRSCHELLEN
C4





ABRAZADERAS
PIPE CLAMPS_ COLLIERS DE FIXATION_ ROHRSCHELLEN

C5
ABRAZADERAS
OTHER PIPE CLAMPS
D'AUTRES COLLIERS
ANDERER ROHRSCHELLEN

ABRAZADERAS

PIPE CLAMPS _ COLLIERS DE FIXATION _ ROHRSCHELLEN

REF.	Ø	METRICA METRIC METRISCH MÉTRIQUE	UNID./ CAJA UNITS/ BOX PIÉCES/ BOITE EINHEITEN/ KASTEN	€/Ud.
------	---	---	---	-------

DOBLE ROSCA M8-10 (ACERO INOXIDABLE AISI-316)

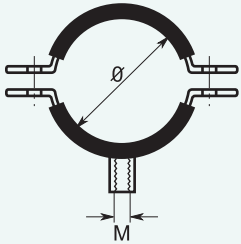
	41AIDR12	21-26	1/2"	10	2,63	
	41AIDR34	26-31	3/4"	10	2,76	
	41AIDR1	33-38	1"	10	2,90	
	41AIDR114	40-45	1 1/4"	10	2,90	
	41AIDR112	47-52	1 1/2"	10	3,29	
	41AIDR54	52-57	54 mm.	10	3,48	
	41AIDR2	60-65	2"	10	3,79	
	41AIDR212	72-77	2 1/2"	10	4,06	
	41AIDR3	87-94	3"	10	4,50	
	41AIDR110	107-114	110 mm.	10	5,11	
	41AIDR4	111-118	4"	10	5,20	
	41AIDR125	121-128	125 mm.	10	5,39	
	41AIDR5	133-140	5"	10	5,78	
	41AIDR154	147-155	154 mm.	10	6,30	
	41AIDR6	158-170	6"	5	6,55	

CON TUERCA (ACERO INOXIDABLE AISI-316)

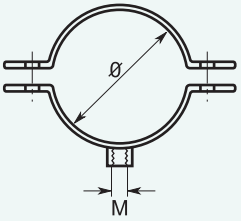

	414ACTU12	12	6	10	0,97	
	414ACTU15	15	6	10	0,97	
	414ACTU18	18	6	10	1,04	
	414ACTU20	20	6	10	1,07	
	414ACTU22	22	6	10	1,10	
	414ACTU25	25	6	10	1,13	
	414ACTU28	28	6	10	1,17	
	414ACTU32	32	6	10	1,23	
	414ACTU35	35	6	10	1,26	
	414ACTU40	40	8	10	1,39	
	414ACTU50	50	8	10	1,49	
	414ACTU54	54	8	10	1,56	
	414ACTU63	63	8	10	1,69	
	414ACTU75	75	8	10	1,82	
	414ACTU90	90	8	10	1,98	
	414ACTU110	110	8	5	2,20	
	414ACTU125	125	10	5	2,37	
	414ACTU160	160	10	5	2,75	
414ACTU200	200	10	5	3,18		

ABRAZADERAS



PIPE CLAMPS_ COLLIERS DE FIXATION_ ROHRSCHELLEN

REF.	Medida Size Dimension Maß	METRICA METRIC METRISCH MÉTRIQUE	UNID./ CAJA UNITS/ BOX PIÉCES/ BOITE EINHEITEN/ KASTEN	€/Ud.
------	------------------------------------	---	---	-------

ABRAZADERA TIPO PERA INOX (AISI-304L)

	41ATP22	22 - 3/4"	8	100	0,86	
	41ATP28	28 - 1"	8	100	1,04	
	41ATP35	35 - 1 1/4"	8	100	1,08	
	41ATP42	42 - 1 1/2"	8	100	1,21	
	41ATP54	54 - 2"	8	100	1,42	
	41ATP76	76 - 2 1/2"	10	100	1,74	
	41ATP88	88 - 3"	10	50	2,08	
	41ATP108	108 - 4"	10	50	2,41	

ABRAZADERA TIPO PERA INOX ISOFÓNICA (AISI-304L)

	41ATPI22	22 - 3/4"	8	100	1,00	
	41ATPI28	28 - 1"	8	100	1,15	
	41ATPI35	35 - 1 1/4"	8	100	1,24	
	41ATPI42	42 - 1 1/2"	8	100	1,36	
	41ATPI54	54 - 2"	8	100	1,64	
	41ATPI76	76 - 2 1/2"	10	100	2,02	
	41ATPI88	88 - 3"	10	50	2,36	
	41ATPI108	108 - 4"	10	50	2,78	

REF.	Diámetro Diameter Diametre Durchmesser	METRICA METRIC METRISCH MÉTRIQUE	UNID./ CAJA UNITS/ BOX PIÉCES/ BOITE EINHEITEN/ KASTEN	€/Ud.
------	---	---	---	-------

ABRAZADERA ALIMENTARIA (AISI-304L)

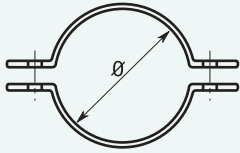
	41AA15	12		100	1,01	
	41AA18	18		100	1,09	
	41AA22	22		50	1,14	
	41AA28	28		50	1,14	
	41AA34	34		50	1,30	
	41AA40	40		50	1,38	
	41AA52	52		25	2,68	
	41AA63	63		25	2,92	
	41AA70	70		25	3,03	
	41AA85	85		20	4,04	
	41AA104	104		15	4,44	
	41AA129	129		8	8,77	
	41AA154	154		5	13,15	

ABRAZADERAS
OTHER PIPE CLAMPS
D'AUTRES COLLIERS
ANDERER ROHRSCHELLEN

C5

ABRAZADERAS

PIPE CLAMPS _ COLLIERS DE FIXATION _ ROHRSCHELLEN

REF.	Ø	METRICA METRIC METRISCH METRIQUE	UNID./ CAJA UNITS/ BOX PIÉCES/ BOITE EINHEITEN/ KASTEN	€/Ud.
------	---	---	---	-------

SINFÍN (ACERO INOXIDABLE AISI-304)

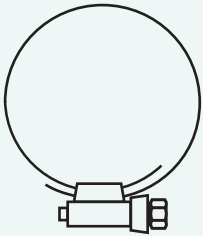
	41ASF10X16	9X0,6	10-16	10	0,56	
	41ASF16X27	12,7X0,7	16-27	10	0,80	
	41ASF25X40	12,7X0,7	25-40	10	1,21	
	41ASF32X50	12,7X0,7	32-60	10	1,23	
	41ASF50X70	12,7X0,7	50-70	10	1,28	
	41ASF70X90	12,7X0,7	70-90	10	1,32	
	41ASF90X110	12,7X0,7	90-110	10	1,66	
	41ASF110X130	12,7X0,7	110-130	10	1,99	
	41ASF130X150	12,7X0,7	130-150	10	2,03	

ABARCONES (ACERO INOXIDABLE AISI-304)

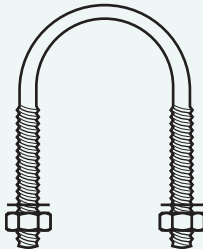
	41A14	14	6	10	0,45	
	41A38	18	6	10	0,52	
	41A12	22	6	10	0,55	
	41A34	28	6	10	0,62	
	41A1	34	6	10	0,65	
	41A39	39	6	10	0,68	
	41A114	43	6	10	0,68	
	41A112	49	6	10	0,78	
	41A53	54	8	10	1,17	
	41A54	55	8	10	1,56	
	41A2	61	8	10	1,56	
	41A65	66	8	5	1,72	
	41A212	77	8	5	1,85	
	41A84	85	8	5	1,98	
	41A3	90	8	5	1,98	
	41A104	105	10	5	3,73	
	41A4	115	10	5	3,92	
	41A129	130	10	5	4,47	
	41A5	144	10	5	4,86	
	41A154	155	10	1	5,02	
41A6	170	10	1	5,25		
41A204	206	10	1	5,96		

ABRAZADERAS

PIPE CLAMPS _ COLLIERS DE FIXATION _ ROHRSCHELLEN

REF.	Ø	METRICA METRIC METRISCH METRIQUE	UNID./ CAJA UNITS/ BOX PIECES/ BOITE EINHEITEN/ KASTEN	€/Ud.
------	---	---	---	-------

SUPER (ACERO INOXIDABLE AISI-316)

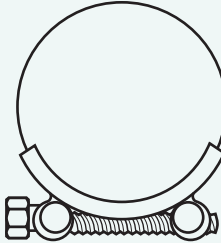
	42SU17X19	Fleje 18x0,8 Tornillo M5x35	17-19	10	1,94		
	42SU20X22		20-22	10	2,01		
	42SU23X25		23-25	10	2,07		
	42SU26X28		26-28	10	2,17		
	42SU29X31		29-31	10	2,24		
	42SU32X35		32-35	10	2,17		
	42SU36X39	Fleje 20x1 Tornillo M6x50	36-39	10	3,14		
	42SU40X43		40-43	10	3,24		
	42SU44X47		44-47	10	3,27		
	42SU48X51		48-51	10	3,34		
	42SU52X55	Fleje 20x1 Tornillo M6x60	52-55	10	3,40		
	42SU56X59		56-59	10	3,24		
	42SU60X63	Fleje 25x1,5 Tornillo M8x70	60-63	5	3,50		
	42SU64X67		64-67	5	6,42		
	42SU68X73		68-73	5	6,52		
	42SU74X79		74-79	5	6,61		
	42SU80X85		80-85	5	6,77		
	42SU86X91		86-91	5	6,90		
	42SU92X97		92-97	5	6,45		
	42SU98X103		98-103	5	7,20		
	42SU104X112		Fleje 25x1,5 Tornillo M8x80	104-112	5		7,46
	42SU113X121			113-121	5		7,65
	42SU122X130	122-130		5	7,88		
	42SU131X139	Fleje 25x1,8 Tornillo M8x80	131-139	5	8,14		
	42SU140X148		140-148	5	8,30		
	42SU149X161		149-161	5	9,53		
	42SU162X174		162-174	5	9,98		
	42SU175X187		175-187	5	10,28		
	42SU188X200		188-200	5	10,60		
	42SU201X213		201-213	5	10,99		
42SU214X226	214-226		5	11,31			
42SU227X239	227-239	5	11,83				

ESPARRAGOS DOBLE ROSCA (ACERO INOXIDABLE AISI-304)

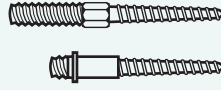
	41EM630X10	06X30X10	-	25	0,32	
	41EM850X10	08X50X10	-	25	0,58	
	41EM860X30	08X60X30	-	25	1,19	
	41EM1060X10	10X60X10	-	25	1,49	
	41EM1060X30	10X60X30	-	25	2,13	



* Consultar / Contact us / Consultez-nous / Nachfragen

ABRAZADERAS



PIPE CLAMPS_ COLLIERS DE FIXATION_ ROHRSCHELLEN

REF.	Medida Size Dimension Maß	METRICA METRIC METRISCH MÉTRIQUE	UNID./ CAJA UNITS/ BOX PIÈCES/ BOITE EINHEITEN/ KASTEN	€/Ud.
------	------------------------------------	---	---	-------



ABRAZADERAS ELÉCTRICAS GRAPA SIMPLE (AISI-304L)

	41AGS15	15	15	-	100	0,18	
	41AGS18	18	18	-	100	0,21	
	41AGS22	22	22	-	100	0,23	
	41AGS28	28	28	-	100	0,27	
	41AGS35	35	35	-	50	0,39	
	41AGS42	42	42	-	50	0,48	

ABRAZADERAS ELÉCTRICAS GRAPA DOBLE (AISI-304L)

	41AGD15	15	15	-	100	0,27	
	41AGD18	18	18	-	100	0,31	
	41AGD22	22	22	-	100	0,36	
	41AGD28	28	28	-	100	0,40	
	41AGD35	35	35	-	50	0,63	
	41AGD42	42	42	-	50	0,70	

ABRAZADERAS ELÉCTRICAS EN U (AISI-304L)

	41AGU15	15	15	-	100	0,24	
	41AGU18	18	18	-	100	0,27	
	41AGU22	22	22	-	100	0,30	
	41AGU28	28	28	-	50	0,31	
	41AGU35	35	35	-	50	0,44	
	41AGU42	42	42	-	50	0,53	

ABRAZADERAS

PIPE CLAMPS_ COLLIERS DE FIXATION_ ROHRSCHELLEN

REF.	Ø	METRICA METRIC METRISCH MÉTRIQUE	UNID./ CAJA UNITS/ BOX PIÈCES/ BOITE EINHEITEN/ KASTEN	€/Ud.
------	---	---	---	-------

TIPO "F" (ACERO INOXIDABLE AISI-316)



41ATF38	16-20	8	10	1,74
41ATF12	21-26	8	10	1,85
41ATF34	26-31	8	10	2,02
41ATF1	33-38	8	10	2,27
41ATF114	40-45	8	10	2,43
41ATF112	47-52	8	10	2,49
41ATF54	52-57	8	10	2,79
41ATF2	60-65	8	10	2,98
41ATF212	72-77	8-10	10	3,56
41ATF3	87-94	8-10	10	3,90
41ATF100	98-105	8-10	10	4,17
41ATF110	107-114	8-10	5	4,23
41ATF4	111-118	8-10	5	4,31
41ATF125	121-128	8-10	5	4,56
41ATF5	133-140	8-10	5	5,03
41ATF154	147-155	8-10	5	5,50
41ATF6	158-170	8-10	5	5,39
41ATF204	198-210	8-10	5	6,49

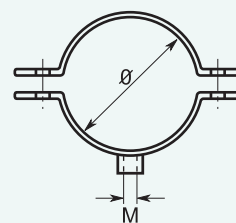

ABRAZADERAS
OTHER PIPE CLAMPS
D'AUTRES COLLIERS
ANDERER ROHRSCHELLEN

C5





VÁLVULAS
VALVES_ BOISSEAUX_ KUGELHÄHNE

C6
VALVULAS
VALVES
BOISSEAUX
KUGELHÄHNE

VÁLVULAS (ACERO INOXIDABLE AISI-316)

VALVES (STAINLESS STEEL AISI-316)_ BOISSEAUX SPHERIQUES (ACIER INOXYDABLE AISI-316)_
KUGELHÄHNE (ROSTFREIEM EDELSTAHL AISI-316)

REF.	MEDIDA SIZE DIMENSION MAG	D	L	A	H	W	€/Ud.
------	------------------------------------	---	---	---	---	---	-------

VÁLVULA DE BOLA PASO TOTAL DOS PIEZAS, ROSCA DIN-2999 PN 64 (1000 PSI WOG)



60V2C14	1/4"	11.6	55	27.5	50	96	9,11
60V2C38	3/8"	12.7	55	27.5	50	96	9,11
60V2C12	1/2"	15	65	32.5	53	96	9,11
60V2C34	3/4"	20	77	38.5	64	125	11,75
60V2C1	1"	25	90	45	66	125	19,22
60V2C114	1 1/4"	32	102	51	79	170	25,14
60V2C112	1 1/2"	38	108	54	83	170	37,92
60V2C2	2"	50.8	125	62.5	94	190	57,10
60V2C212	2 1/2"	65	167	83.5	136	250	125,66
60V2C3	3"	77	181	90.5	149	250	148,79

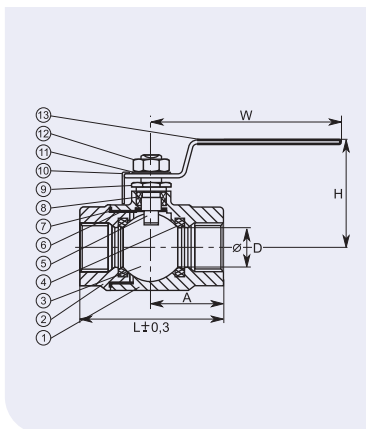

Nº	DESCRIPCIÓN DESCRIPTION DESCRIPTION BESCHREIBUNG	MATERIAL MATERIAL MATERIAL MATERIAL
1	Cuerpo_ Body_ Corps_ Körper	316
2	Tapa_ Cover_ Couverture_ Decke	316
3	Bola_ Ball_ Boule_ Kugel	316
4	Asiento bola_ Ball seat_ Place de boule_ Ball-Sitz	PTFE
5	Eje_ Axis_ Axe_ Achse	304
6	Junta_ Joint_ Joint_ Gelenk	PTFE
7	Junta_ Joint_ Joint_ Gelenk	PTFE
8	Empaquetadura_ Packing washer_ Couvercle_ Deckel	PTFE
9	Prensa estopa_ Gland packing_ Bague presse_ Stopfbuchsenpkg	304
10	Maneta_ Handle_ Poignée_ Griff	304
11	Arandela_ Washer_ Rondelle_ Scheibe	304
12	Tuerca_ Nut_ Noix_ Nuß	304
13	Funda maneta_ Handle Cover_ Couverture de poignée_ Griff-Decke	PVC

RATIO PRESIÓN-TEMPERATURA

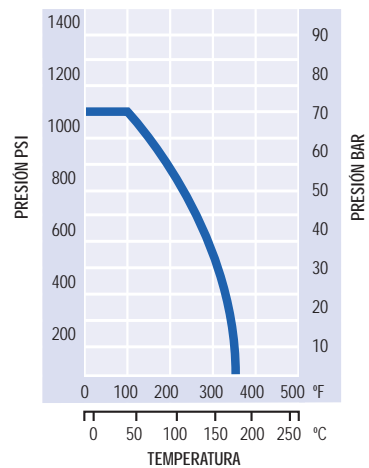



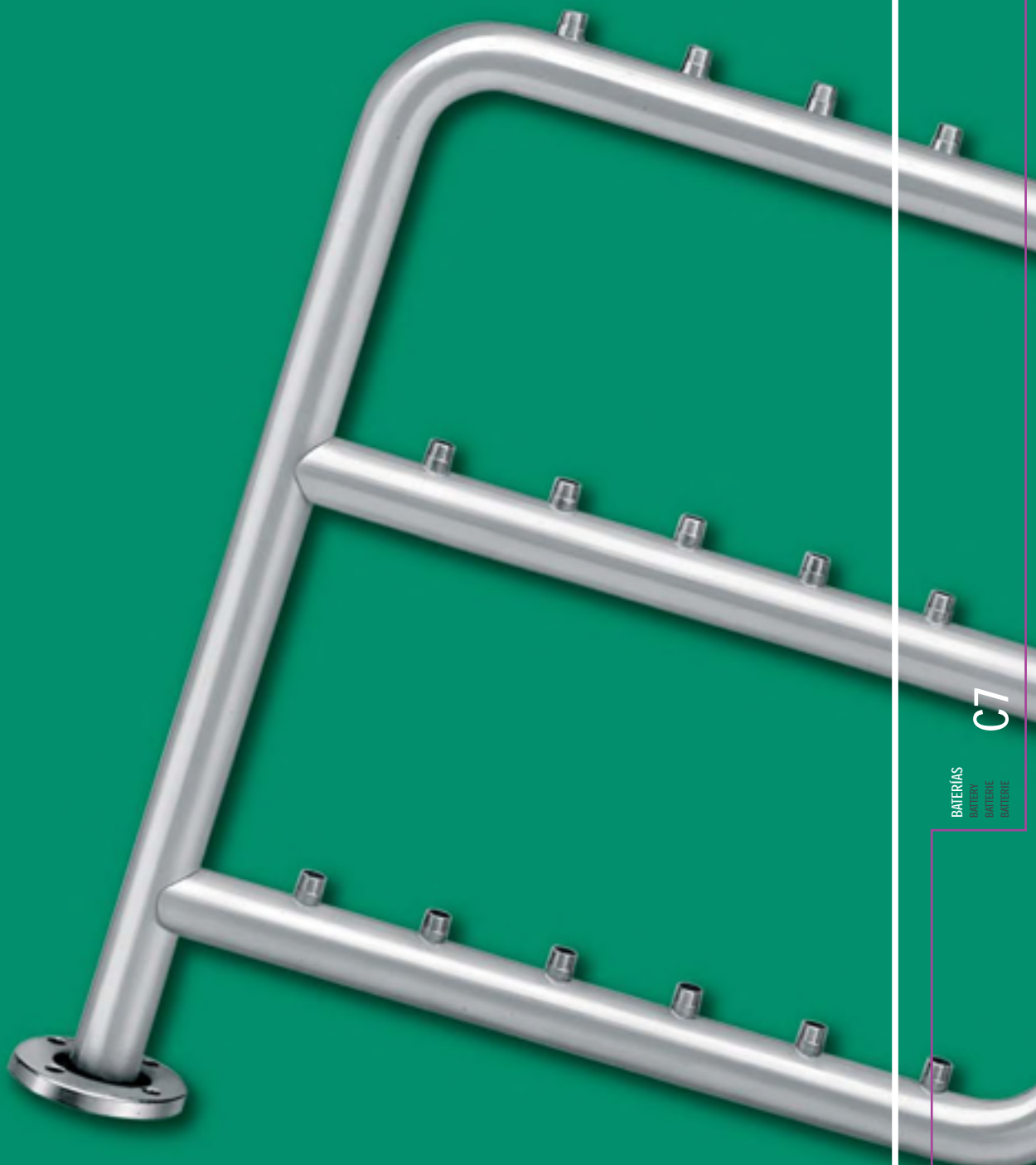

BATERÍAS
BATTERY_ BATTERIE_ BATTERIE

BATERÍAS
BATTERY
BATTERIE
BATTERIE

C7

BATERÍAS PARA CONTADORES DE AGUA (ACERO INOXIDABLE AISI-316)

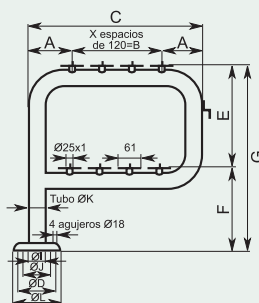
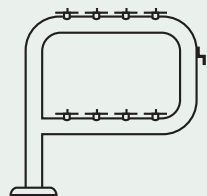

BATERÍA 2 FILAS	A	B	C	D	E	F	G	I	J	L	X	Ø K PARED LISA
2 filas, 4 salidas	154	120	428	125	415	200	615	60	102	165	1	(D Int. 51,6)
2 filas, 6 salidas	154	240	548	125	415	200	615	60	102	165	2	(D Int. 51,6)
2 filas, 8 salidas	147	360	654	145	415	200	615	70	102	185	3	(D Int. 60,5)
2 filas, 10 salidas	147	480	774	145	415	200	615	70	102	185	4	(D Int. 60,5)
2 filas, 12 salidas	147	600	894	145	415	200	615	70	102	185	5	(D Int. 60,5)
2 filas, 14 salidas	147	720	1014	145	415	200	615	70	102	185	6	(D Int. 60,5)
2 filas, 16 salidas	147	840	1134	145	415	200	615	70	102	185	7	(D Int. 60,5)
2 filas, 20 salidas	147	1080	1374	145	415	200	615	70	102	185	9	(D Int. 60,5)
2 filas, 22 salidas	147	1200	1494	145	415	200	615	70	102	185	10	(D Int. 60,5)
2 filas, 26 salidas	147	1440	1734	145	415	200	615	70	102	185	12	(D Int. 60,5)

Tubería	Bocas	Filas	€/Ud. Tipo P	€/Ud. Tipo T	€/Ud. Tipo L	€/Ud. Tipo A	€/Ud. Tipo Q	€/Ud. Tipo S
2"	4	2	*	*	-	-	-	-
2"	6	2	*	*	-	-	-	*
2 1/2"	8	2	-	-	-	-	-	*
2 1/2"	10	2	*	*	*	*	*	*
2 1/2"	12	2	*	*	*	*	*	*
2 1/2"	14	2	*	*	*	*	*	*
2 1/2"	16	2	*	*	*	*	*	*
2 1/2"	20	2	*	*	*	*	*	*
2 1/2"	22	2	*	*	*	*	*	*
2 1/2"	26	2	*	*	*	*	*	*

CONFIGURACIONES

TIPO "P"

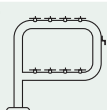

TIPO "T"

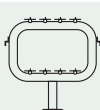

TIPO "L"

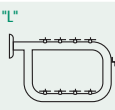

TIPO "A"



TIPO "S"

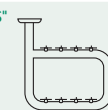

TIPO "Q"

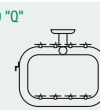

BATERÍAS PARA CONTADORES DE AGUA (ACERO INOXIDABLE AISI-316)

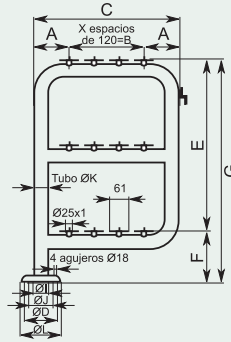
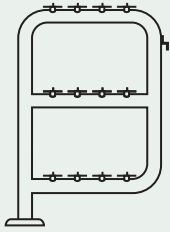

BATERÍA 3 FILAS	A	B	C	D	E	F	G	I	J	L	X	Ø K PARED LISA
3 filas, 6 salidas	154	120	428	145	830	200	1030	615	70	102	1	(D Int. 51,6)
3 filas, 9 salidas	147	240	534	145	830	200	1030	615	70	102	2	(D Int. 60,5)
3 filas, 12 salidas	147	360	654	145	830	200	1030	615	70	102	3	(D Int. 60,5)
3 filas, 15 salidas	147	480	774	145	830	200	1030	615	70	102	4	(D Int. 60,5)
3 filas, 18 salidas	147	600	894	145	830	200	1030	615	70	102	5	(D Int. 60,5)
3 filas, 21 salidas	147	720	1014	145	830	200	1030	615	70	102	6	(D Int. 60,5)
3 filas, 24 salidas	147	840	1134	145	830	200	1030	615	70	102	7	(D Int. 60,5)
3 filas, 27 salidas	147	960	1254	145	830	200	1030	615	70	102	8	(D Int. 60,5)
3 filas, 30 salidas	147	1080	1374	145	830	200	1030	615	70	102	9	(D Int. 60,5)
3 filas, 33 salidas	184	1200	1568	160	830	300	1130	715	90	138	10	(D Int. 80)
3 filas, 36 salidas	184	1320	1688	160	830	300	1130	715	90	138	11	(D Int. 80)
3 filas, 39 salidas	184	1440	1808	160	830	300	1130	715	90	138	12	(D Int. 80)
3 filas, 42 salidas	184	1560	1928	160	830	300	1130	715	90	138	13	(D Int. 80)
3 filas, 45 salidas	184	1680	2048	160	830	300	1130	715	90	138	14	(D Int. 80)

Tubería	Bocas	Filas	€/Ud. Tipo P	€/Ud. Tipo T	€/Ud. Tipo L	€/Ud. Tipo A	€/Ud. Tipo Q	€/Ud. Tipo S
2"	6	3	*	*	-	-	-	-
2 1/2"	9	3	*	*	*	*	*	*
2 1/2"	12	3	*	*	*	*	*	*
2 1/2"	15	3	*	*	*	*	*	*
2 1/2"	18	3	*	*	*	*	*	*
2 1/2"	21	3	*	*	*	*	*	*
2 1/2"	24	3	*	*	*	*	*	*
2 1/2"	27	3	*	*	*	*	*	*
2 1/2"	30	3	*	*	*	*	*	*
3"	33	3	*	-	*	-	*	*
3"	36	3	*	-	*	-	*	*
3"	39	3	*	-	*	-	*	*
3"	42	3	*	-	-	-	*	*
3"	45	3	*	-	-	-	*	*

CONFIGURACIONES

TIPO "P"

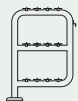

TIPO "T"



TIPO "L"

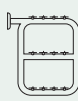

TIPO "A"



TIPO "S"

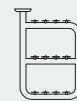

TIPO "Q"

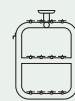

BATERÍAS PARA CONTADORES DE AGUA (ACERO INOXIDABLE AISI-316L)

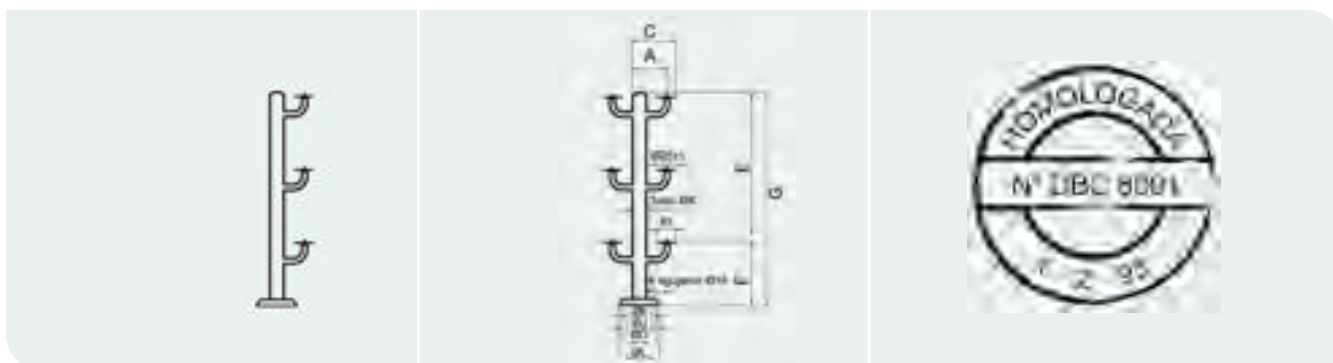

BATERÍA TIPO I	A	B	C	D	E	F	G	I	J	L	Ø K PARED LISA	€/Ud.
2 salidas	121	-	164	145	266	214	480	70	102	165	(D Int. 51,6)	*
3 salidas	121	-	164	145	516	214	730	70	102	165	(D Int. 51,6)	*
4 salidas	121	-	164	145	766	214	980	70	102	165	(D Int. 51,6)	*
5 salidas	130	-	173	145	1016	214	1230	70	102	165	(D Int. 51,6)	*
6 salidas	130	-	173	145	1266	214	1480	70	102	165	(D Int. 51,6)	*
8 salidas	130	-	173	145	1766	214	1980	70	102	185	(D Int. 60,5)	*

BATERÍA TIPO CANDELABRO	A	B	C	D	E	F	G	I	J	L	Ø K PARED LISA	€/Ud.
2 salidas	121	-	164	145	31	214	245	70	102	185	(D Int. 60,5)	*
4 salidas	121	-	164	145	281	214	495	70	102	185	(D Int. 60,5)	*
6 salidas	121	-	164	145	531	214	745	70	102	185	(D Int. 60,5)	*
8 salidas	121	-	164	145	781	214	995	70	102	185	(D Int. 60,5)	*
10 salidas	121	-	164	145	1031	214	1245	70	102	185	(D Int. 60,5)	*
14 salidas	130	-	173	145	1531	214	1745	70	102	185	(D Int. 60,5)	*

REF.	Ø	€/Ud.
------	---	-------

ACCESORIOS

BRIDA ROSCADA CADMIADA	50B2	2"	*
BRIDA ROSCADA CADMIADA	50B212	2 1/2"	*
BRIDA ROSCADA CADMIADA	50B3	3"	*
GANCHO INOXIDABLE	50GB8	-	*
JUNTA NEOPRENO 3MM. 2"	50JN2	2"	*
JUNTA NEOPRENO 3MM. 2 1/2"	50JN212	2 1/2"	*
JUNTA NEOPRENO 3MM. 3"	50JN3	3"	*
PLETINA CIEGA + TORNILLOS INOX	50PC	-	*
TORNILLO TUERCA Y ARANDELA M16X70 INOX	50TTA16X70	-	*



ACCESORIOS ROSCADOS

TREADED FITTINGS_ ACCESSOIRES FILETÉS_ GEWINDEFITTINGE

ACC. ROSCADOS
TREADED FITTINGS
ACCESSOIRES FILETÉS
GEWINDEFITTINGE

C8

ACCESORIOS ROSCADOS (ACERO INOXIDABLE AISI-316)_

TREADED FITTINGS (STAINLESS STEEL AISI-316)_ ACCESSOIRES FILETÉS (ACIER INOXYDABLE AISI-316)_
GEWINDEFITTINGE (ROSTFREIEM EDELSTAHL AISI-316)

REF.	MEDIDA SIZE DIMENSION MM	A	B	€/Ud.
------	-----------------------------------	---	---	-------

CODO 90° HH



224F9018	1/8"	16	-	1,47
224F9014	1/4"	20	-	1,47
224F9038	3/8"	24	-	1,69
224F9012	1/2"	28	-	2,56
224F9034	3/4"	33	-	2,70
224F901	1"	38	-	4,54
224F90114	1 1/4"	45	-	7,10
224F90112	1 1/2"	49	-	8,57
224F902	2"	57	-	16,85
224F90212	2 1/2"	69	-	27,35
224F903	3"	78	-	33,09
224F904	4"	96	-	*

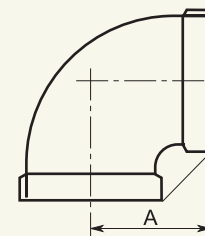

FIG. 90

CODO 90° HM



224F9218	1/8"	16	26	1,69
224F9214	1/4"	20	30	1,69
224F9238	3/8"	24	36	2,18
224F9212	1/2"	28	41	2,33
224F9234	3/4"	33	48	2,97
224F921	1"	38	54	4,76
224F92114	1 1/4"	45	62	8,30
224F92112	1 1/2"	49	68	12,00
224F922	2"	57	80	17,03
224F92212	2 1/2"	69	92	26,18
224F923	3"	78	104	37,79
224F924	4"	96	126	*

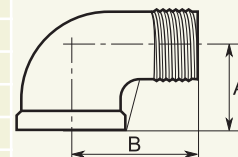

FIG. 92

CODO 45° HH



224F12018	1/8"	19	-	1,97
224F12014	1/4"	19	-	1,97
224F12038	3/8"	21	-	2,19
224F12012	1/2"	22	-	2,25
224F12034	3/4"	25	-	2,65
224F1201	1"	29	-	4,84
224F120114	1 1/4"	33	-	7,12
224F120112	1 1/2"	36	-	9,14
224F1202	2"	43	-	14,69
224F120212	2 1/2"	49	-	27,60
224F1203	3"	54	-	30,75
224F1204	4"	65	-	*

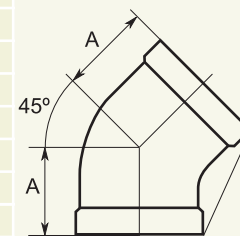

FIG. 120

ACCESORIOS ROSCADOS (ACERO INOXIDABLE AISI-316)_

TREADED FITTINGS (STAINLESS STEEL AISI-316)_ ACCESSOIRES FILETÉS (ACIER INOXYDABLE AISI-316)_
GEWINDEFITTINGE (ROSTFREIEM EDELSTAHL AISI-316)

REF.	MEDIDA SIZE DIMENSION MMB	A	B	€/Ud.
------	------------------------------------	---	---	-------

TE IGUAL



224F13018	1/8"	19	-	2,09
224F13014	1/4"	20	-	2,09
224F13038	3/8"	24	-	2,61
224F13012	1/2"	28	-	3,14
224F13034	3/4"	33	-	3,67
224F1301	1"	38	-	6,10
224F130114	1 1/4"	45	-	9,82
224F130112	1 1/2"	49	-	15,08
224F1302	2"	57	-	18,45
224F130212	2 1/2"	69	-	37,24
224F1303	3"	78	-	46,25
224F1304	4"	96	-	71,37

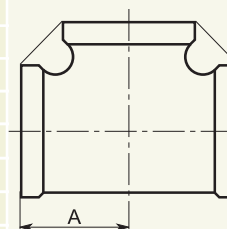
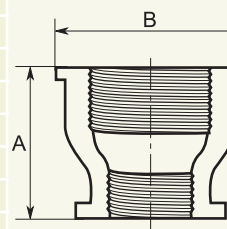

FIG. 130

MANGUITO REDUCIDO



224F24014	1/4" x 1/8"	27	21	1,55
224F24038	3/8" x 1/4"	28	26	1,95
224F24012	1/2" x 3/8"	34	30	2,20
224F24034	3/4" x 1/2"	38	36	2,69
224F2401	1" x 3/4"	42	44	4,52
224F240114	1 1/4" x 1"	48	53	6,52
224F240112X12	1 1/2" x 1/2"	35	50	8,04
224F240112x1	1 1/2" x 1"	35	50	8,04
224F240112	1 1/2" x 1 1/4"	52	60	8,04
224F2402	2" x 1 1/2"	52	60	12,49
224F240212	2 1/2" x 2"	58	73	21,76
224F2403	3" x 2 1/2"	65	91	28,86



MANGUITO HH



224F27018	1/8"	17	15	1,42
224F27014	1/4"	25	18	1,42
224F27038	3/8"	26	22	1,93
224F27012	1/2"	34	27	2,33
224F27034	3/4"	36	33	3,06
224F2701	1"	43	40	4,35
224F270114	1 1/4"	48	49	6,78
224F270112	1 1/2"	50	55	7,12
224F2702	2"	56	67	11,70
224F270212	2 1/2"	65	83	30,37
224F2703	3"	71	96	33,56
224F2704	4"	83	123	*

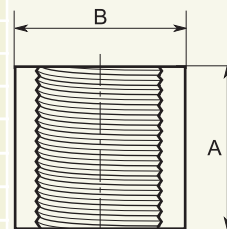

FIG. 270

ACCESORIOS ROSCADOS (ACERO INOXIDABLE AISI-316)_

TREADED FITTINGS (STAINLESS STEEL AISI-316)_ ACCESSOIRES FILETÉS (ACIER INOXYDABLE AISI-316)_
GEWINDEFITTINGE (ROSTFREIEM EDELSTAHL AISI-316)

REF.	MEDIDA SIZE DIMENSION MM	A	B	€/Ud.
------	-----------------------------------	---	---	-------

TUERCA REDUCIDA HM

	224F24114	1/4" x 1/8"	19	16	1,61
	224F24138	3/8" x 1/4"	18	20	1,61
	224F24112X14	1/2" x 1/4"	22	24	2,07
	224F24112	1/2" x 3/8"	22	24	2,07
	224F24134X38	3/4" x 3/8"	24	30	2,66
	224F24134	3/4" x 1/2"	24	30	2,66
	224F2411X12	1" x 1/2"	27	37	3,92
	224F2411X34	1" x 3/4"	27	37	3,92
	224F241114X12	1 1/4" x 1/2"	31	46	5,26
	224F241114X34	1 1/4" x 3/4"	31	46	5,26
	224F241114X1	1 1/4" x 1"	31	46	5,26
	224F241112X34	1 1/2" x 3/4"	32	52	7,44
	224F241112X1	1 1/2" x 1"	32	52	7,44
	224F241112X114	1 1/2" x 1 1/4"	32	52	7,44
	224F2412X1	2" x 1"	37	64	11,48
	224F2412X114	2" x 1 1/4"	37	64	11,48
	224F2412X112	2" x 1 1/2"	37	64	11,48
	224F241212	2 1/2" x 2"	40	80	20,93
	224F2413	3" x 2 1/2"	44	94	32,89

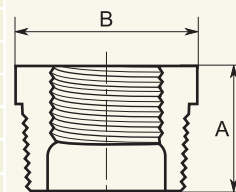

FIG. 241

MACHÓN REDUCIDO

	224F24514	1/4 x 1/8"	16	34	1,51
	224F24538	3/8" x 1/4"	19	35	1,51
	224F24512X14	1/2" x 1/4"	23	38	2,11
	224F24512	1/2" x 3/8"	23	38	2,11
	224F24534X38	3/4" x 3/8"	29	41	2,38
	224F24534X12	3/4" x 1/2"	29	41	2,38
	224F2451X12	1" x 1/2"	36	46	3,22
	224F2451X34	1" x 3/4"	36	47	3,22
	224F245114X12	1 1/4" x 1/2"	46	48	4,79
	224F245114X34	1 1/4" x 3/4"	46	51	4,79
	224F245114X1	1 1/4" x 1"	46	53	4,79
	224F245112X34	1 1/2" x 3/4"	53	50	6,09
	224F245112X1	1 1/2" x 1"	53	55	6,09
	224F245112X114	1 1/2" x 1 1/4"	53	56	6,09
	224F2452X1	2" x 1"	65	60	9,68
	224F2452X114	2" x 1 1/4"	65	63	9,68
	224F2452	2" x 1 1/2"	65	64	9,68
	224F245212	2 1/2" x 2"	80	74	16,62
	224F2453	3" x 2 1/2"	92	81	24,47

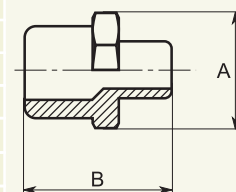

FIG. 245

ACCESORIOS ROSCADOS (ACERO INOXIDABLE AISI-316)

TREADED FITTINGS (STAINLESS STEEL AISI-316) ACCESSOIRES FILETÉS (ACIER INOXYDABLE AISI-316)
GEWINDEFITTINGE (ROSTFREIEM EDELSTAHL AISI-316)

REF.	MEDIDA SIZE DIMENSION NAB	A	B	€/Ud.
------	------------------------------------	---	---	-------

MACHÓN



224F28018	1/8"	25	12	1,31
224F28014	1/4"	33	16	1,31
224F28038	3/8"	35	20	1,53
224F28012	1/2"	42	24	1,85
224F28034	3/4"	47	30	2,57
224F2801	1"	52	37	3,47
224F280114	1 1/4"	56	46	5,08
224F280112	1 1/2"	59	52	6,20
224F2802	2"	66	64	9,27
224F280212	2 1/2"	72	80	18,01
224F2803	3"	80	94	21,39
224F2804	4"	91	120	*

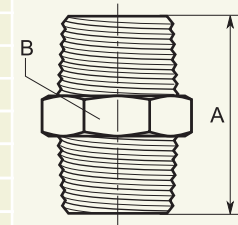

FIG. 280

TAPÓN MACHO



224F29018	1/8"	19	12	1,04
224F29014	1/4"	19	16	1,04
224F29038	3/8"	22	20	1,29
224F29012	1/2"	24	24	1,31
224F29034	3/4"	27	30	1,56
224F2901	1"	30	37	2,87
224F290114	1 1/4"	37	46	3,54
224F290112	1 1/2"	38	52	4,82
224F2902	2"	41	64	7,86
224F290212	2 1/2"	51	80	19,79
224F2903	3"	54	94	21,39
224F2904	4"	59	120	*

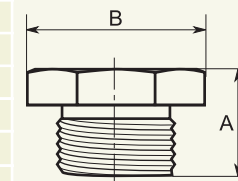

FIG. 290

TAPÓN HEMBRA



224F30018	1/8"	14	16	1,40
224F30014	1/4"	15	18	1,40
224F30038	3/8"	17	22	1,40
224F30012	1/2"	20	27	1,86
224F30034	3/4"	24	33	2,53
224F3001	1"	28	40	3,40
224F300114	1 1/4"	30	49	4,95
224F300112	1 1/2"	32	55	7,05
224F3002	2"	36	68	9,62
224F300212	2 1/2"	42	85	22,21
224F3003	3"	45	98	26,29
224F3004	4"	55	125	*

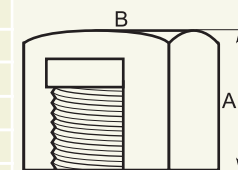



FIG. 300

ACCESORIOS ROSCADOS (ACERO INOXIDABLE AISI-316)_

TREADED FITTINGS (STAINLESS STEEL AISI-316)_ ACCESSOIRES FILETÉS (ACIER INOXYDABLE AISI-316)_
GEWINDEFITTINGE (ROSTFREIEM EDELSTAHL AISI-316)

REF.	MEDIDA SIZE DIMENSION MMS	A	B	€/Ud.
------	------------------------------------	---	---	-------

CONTRATUERCA

	224F31218	1/8"	-	-	*
	224F31214	1/4"	6	22	0,93
	224F31238	3/8"	7	27	1,08
	224F31212	1/2"	8	32	1,46
	224F31234	3/4"	9	37	1,80
	224F3121	1"	10	46	2,37
	224F312114	1 1/4"	11	55	3,26
	224F312112	1 1/2"	12	62	4,02
	224F3122	2"	13	76	6,15





FIG. 312

ENLACE 3 PIEZAS HM

	224F34118	1/8"	-	-	*
	224F34114	1/4"	31	54	4,31
	224F34138	3/8"	37	58	4,58
	224F34112	1/2"	42	65	5,90
	224F34134	3/4"	49	70	6,85
	224F3411	1"	59	79	11,53
	224F341114	1 1/4"	69	89	16,08
	224F341112	1 1/2"	78	94	21,47
	224F3412	2"	93	106	29,80
	224F341212	2 1/2"	112	117	48,06
	224F3413	3"	127	130	60,74
	224F3414	4"	158	115	79,66

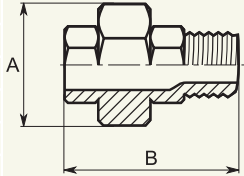



FIG. 341

ENLACE 3 PIEZAS HH

	224F34018	1/8"	-	-	*
	224F34014	1/4"	34	31	4,12
	224F34038	3/8"	38	37	4,19
	224F34012	1/2"	41	42	5,65
	224F34034	3/4"	49	49	7,40
	224F3401	1"	55	59	10,19
	224F340114	1 1/4"	60	69	15,59
	224F340112	1 1/2"	66	78	23,38
	224F3402	2"	74	93	30,26
	224F340212	2 1/2"	85	112	45,76
	224F3403	3"	94	127	46,95
	224F3404	4"	115	158	128,23

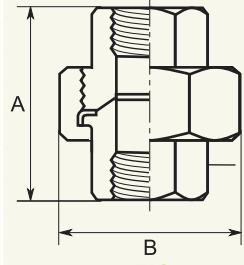

FIG. 340

ACCESORIOS ROSCADOS (ACERO INOXIDABLE AISI-316)_

TREADED FITTINGS (STAINLESS STEEL AISI-316)_ ACCESSOIRES FILETÉS (ACIER INOXYDABLE AISI-316)_
GEWINDEFITTINGE (ROSTFREIEM EDELSTAHL AISI-316)

REF.	MEDIDA SIZE DIMENSION MAB	A	B	€/Ud.
------	------------------------------------	---	---	-------

ENTRONQUE



224F14918	1/8"	-	30	0,89
224F14914	1/4"	-	30	0,89
224F14938	3/8"	-	30	0,89
224F14912	1/2"	-	35	1,77
224F14934	3/4"	-	40	2,41
224F1491	1"	-	40	2,90
224F149114	1 1/4"	-	50	5,46
224F149112	1 1/2"	-	50	6,65
224F1492	2"	-	50	10,08
224F149212	2 1/2"	-	60	13,51
224F1493	3"	-	70	21,47
224F1494	4"	-	80	*

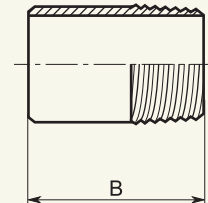

FIG. 149

ENTRONQUE MANGUERA



224F39918	1/8"	-	40	1,86
224F39914	1/4"	-	41	1,86
224F39938	3/8"	-	45	2,33
224F39912	1/2"	-	50	2,57
224F39934	3/4"	-	65	3,76
224F3991	1"	-	70	4,77
224F399114	1 1/4"	-	82	6,94
224F399112	1 1/2"	-	95	9,70
224F3992	2"	-	100	14,24
224F399212	2 1/2"	-	-	38,15
224F3993	3"	-	-	*
224F3994	4"	-	-	*

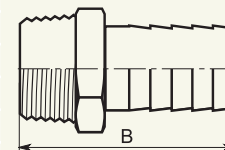

FIG. 399





BRIDAS
FLANGES_BRIDES_FLANSCH

BRIDAS
FLANGES
BRIDES
FLANSCH

C9

BRIDAS PLANAS PARA SOLDAR

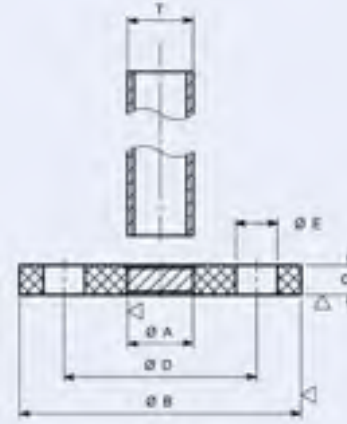
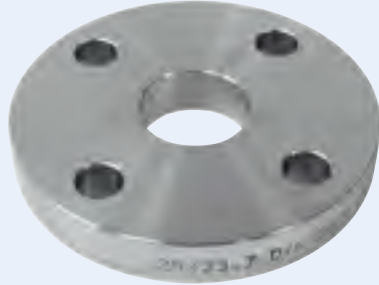

REF. AISI 304L	REF. AISI 316L	DN	T/TUBO TUBE TUBE ROHR	A	B	C	D	TORNILLOS SCREWS VIS SCHRAUBEN	M	E	kg/u	€/Ud.
-------------------	-------------------	----	--------------------------------	---	---	---	---	---	---	---	------	-------

DIN 2576 - PN10_TUBO_TUBE_TUBE_ROHR ISO EN 1091-1-01 PN10

282BPI15	284BPI15	PN40	15	21,3	22	95	14	65	4	M12	14	0,67	*
282BPI20	284BPI20		20	26,9	27,5	105	16	75	4	M12	14	0,94	*
282BPI25	284BPI25		25	33,7	34,5	115	16	85	4	M12	14	1,11	*
282BPI32	284BPI32		32	42,4	43,5	140	18 (16)	100	4	M16	18	1,62	*
282BPI40	284BPI40		40	48,3	49,5	150	18 (16)	110	4	M16	18	1,86	*
282BPI50	284BPI50	PN16	50	60,3	61,5	165	19 (18)	125	4	M16	18	2,47	*
282BPI65	284BPI65		65	76,1	77,5	185	20 (18)	145	4	M16	18	3	*
282BPI80	284BPI80		80	88,9	90,5	200	20	160	8	M16	18	3,79	*
282BPI100	284BPI100	100	114,3	116	220	22 (20)	180	8	M16	18	4,03	*	
282BPI125	284BPI125	125	139,7	141,5	250	22	210	8	M16	18	5,46	*	
282BPI150	284BPI150	PN10	150	168,3	170,5	285	22	240	8	M20	22	6,57	*
282BPI200	284BPI200		200	219,1	221,5	340	24	295	8	M20	22	9,31	*
282BPI250	284BPI250		250	273	276,5	395	26	350	12	M20	22	11,9	*
282BPI300	284BPI300		300	323,9	327,5	445	26	400	12	M20	22	13,8	*

() Medidas según norma DIN 2576 / Measures according to DIN 2576/ Mesures selon la norme DIN 2576 / Maßnahmen nach DIN 2576

DIN 2576 - PN10 TUBO MM TUBO_TUBE_TUBE_ROHR MM EN 1092-1-01

282BPM15	284BPM15	PN40	15	18	18,5	95	14	65	4	M12	14	0,67	*
282BPM20	284BPM20		20	23	23,5	105	16	65	4	M12	14	0,94	*
282BPM25	284BPM25		25	28	28,5	115	16	75	4	M12	14	1,11	*
282BPM32	284BPM32		32	38	38,5	140	18 (16)	85	4	M16	18	1,62	*
282BPM40	284BPM40		40	43	43,5	150	18 (16)	100	4	M16	18	1,86	*
282BPM50	284BPM50	PN16	50	53	53,5	165	19 (18)	110	4	M16	18	2,47	*
282BPM65	284BPM65		65	73	73,7	185	20 (18)	125	4	M16	18	3	*
282BPM80	284BPM80		80	84	84,7	200	20	145	8	M16	18	3,79	*
282BPM100	284BPM100	100	104	104,8	220	22 (20)	160	8	M16	18	4,03	*	
282BPM125	284BPM125	125	129	130	250	22	180	8	M16	18	5,46	*	
282BPM150	284BPM150	PN10	150	154	156	285	22	210	8	M20	22	6,57	*
282BPM200	284BPM200		200	204	206	340	24	240	8	M20	22	9,31	*
282BPM250	284BPM250		250	254	256	395	26	295	12	M20	22	11,9	*
282BPM300	284BPM300		300	304	307	445	26	350	12	M20	22	13,8	*

() Medidas según norma DIN 2576 / Measures according to DIN 2576/ Mesures selon la norme DIN 2576 / Maßnahmen nach DIN 2576

BRIDA ROSCADA

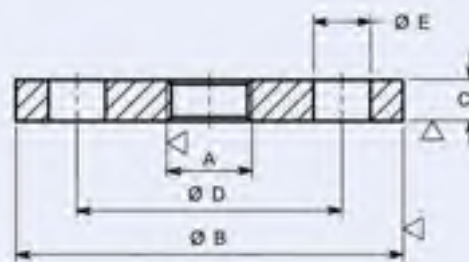

REF. AISI 304L	REF. AISI 316L	DN	T/TUBO TUBE TUBE ROHR	A	B	C	D	TORNILLOS SCREWS VIS SCHRAUBEN	M	E	kg/u	€/Ud.
DIN2576 - PN10 EN 1092-1-01 PN10												
282BPR15	284BPR15	15	21,3	1/2"	95	14	65	4	M12	14	0,669	*
282BPR20	284BPR20	20	26,9	3/4"	105	16	75	4	M12	14	0,936	*
282BPR25	284BPR25	25	33,7	1"	115	16	85	4	M12	14	1,11	*
282BPR32	284BPR32	32	42,4	1 1/4"	140	18 (16)	100	4	M16	18	1,62	*
282BPR40	284BPR40	40	48,3	1 1/2"	150	18 (16)	110	4	M16	18	1,86	*
282BPR50	284BPR50	50	60,3	2"	165	19 (18)	125	4	M16	18	2,47	*
282BPR65	284BPR65	65	76,1	2 1/2"	185	20 (18)	145	4	M16	18	3	*
282BPR80	284BPR80	80	88,9	3"	200	20	160	8	M16	18	3,79	*
282BPR100	284BPR100	100	114,3	4"	220	22 (20)	180	8	M16	18	4,03	*

() Medidas según norma DIN 2576 / Measures according to DIN 2576 / Mesures selon la norme DIN 2576 / Maßnahmen nach DIN 2576

BRIDA CIEGA

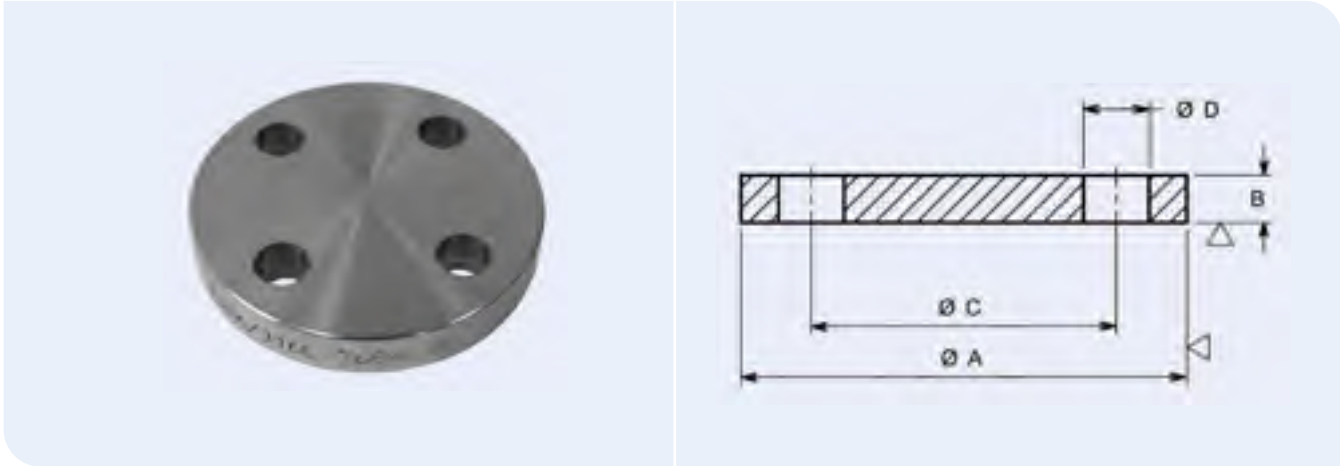

REF. AISI 304L	REF. AISI 316L	DN	A	B	C	TORNILLOS SCREWS VIS SCHRAUBEN	M	D	kg/u	€/Ud.	
DIN 2527 - PN10 EN 1092-1-05 PN10											
282BC15	284BC15	PN40	15	95	16 (14)	65	4	M12	14	0,72	*
282BC20	284BC20		20	105	18 (16)	75	4	M12	14	1,01	*
282BC25	284BC25		25	115	18 (16)	85	4	M12	14	1,23	*
282BC32	284BC32		32	140	18 (16)	100	4	M16	18	1,8	*
282BC40	284BC40		40	150	18 (16)	110	4	M16	18	2,09	*
282BC50	284BC50	PN16	50	165	18	125	4	M16	18	2,88	*
282BC65	284BC65		65	185	18	145	4	M16	18	3,66	*
282BC80	284BC80		80	200	20	160	8	M16	18	4,77	*
282BC100	284BC100	PN10	100	220	20	180	8	M16	18	5,65	*
282BC125	284BC125		125	250	22	210	8	M16	18	8,42	*
282BC150	284BC150		150	285	22	240	8	M20	22	10,4	*
282BC200	284BC200		200	340	24	295	8	M20	22	16,5	*

() Medidas según norma DIN 2576 / Measures according to DIN 2576/ Mesures selon la norme DIN 2576 / Maßnahmen nach DIN 2576

BRIDA CON CUELLO

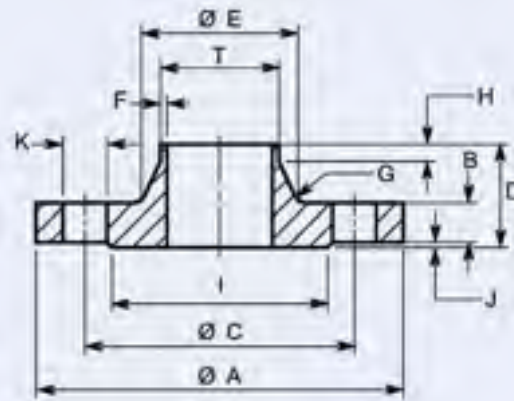

REF. AISI 304L	REF. AISI 316L	DN	T/TUBO TUBE TUBE ROHR	A	B	C	D	E	F	G	H	I	J	TORNILLOS SCREWS VIS SCHRAUBEN	M	K	kg/u	€/Ud.
-------------------	-------------------	----	--------------------------------	---	---	---	---	---	---	---	---	---	---	---	---	---	------	-------

DIN 2633-PN16 EN 1092-1-11 PN16

282BCC15	284BCC15	PN40	15	21,3	95	16 (14)	65	32	2	4	6	45	2	4	M12	14	0,65	*	
282BCC20	284BCC20		20	26,9	105	18 (16)	75	38	40	2,3	4	6	58	2	4	M12	14	0,95	*
282BCC25	284BCC25		25	33,7	115	18 (16)	85	38	45	2,6	4	6	68	2	4	M12	14	1,14	*
282BCC32	284BCC32		32	42,4	140	18 (16)	100	40	56	2,6	6	6	78	2	4	M16	18	1,69	*
282BCC40	284BCC40		40	48,3	150	18 (16)	110	42	64	2,6	6	7	88	2	4	M16	18	1,86	*
282BCC50	284BCC50	PN16	50	60,3	165	18	125	45	75	2,9	6	8	102	2	4	M16	18	2,53	*
282BCC65	284BCC65		65	76,1	185	18	145	45	90	2,9	6	10	122	2	4	M16	18	3,06	*
282BCC80	284BCC80		80	88,9	200	20	160	50	105	3,2	8	10	138	2	8	M16	18	3,7	*
282BCC100	284BCC100		100	114,3	220	20	180	52	131	3,6	8	12	158	2	8	M16	18	4,62	*
282BCC125	284BCC125		125	139,7	250	22	210	55	156	4	8	12	188	2	8	M16	18	6,3	*
282BCC150	284BCC150	PN10	150	168,3	285	22	240	55	184	4,5	10	12	212	2	8	M20	22	7,75	*
282BCC200	284BCC200		200	219,1	340	24	295	62	235	5,9	10	16	268	2	12	M20	22	11	*

() Medidas según norma DIN 2633 / Measures according to DIN 2633 / Mesures selon la norme DIN 2633 / Maßnahmen nach DIN 2633



ACCESORIOS DE COMPRESIÓN

COMPRESSION FITTINGS_ RACCORDS À COMPRESSION_ SCHNEIDRINGVERSCHRAUBUNGEN

ACCESORIOS DE COMPRESIÓN DIN-2353 (ACERO INOXIDABLE AISI-316)

COMPRESSION FITTINGS DIN-2353 (STAINLESS STEEL AISI-316) _ RACCORDS À COMPRESSION (ACIER INOXYDABLE AISI-316) _ SCHNEIDRINGVERSCHRAUBUNGEN NACH DIN-2353 (ROSTFREIEM EDELSTAHL AISI-316)

REF.	Ø	L	I	S ₁	S ₂	€/Ud.
------	---	---	---	----------------	----------------	-------

UNIÓN DOBLE



31UD06	6	39	10	14	12	12,06
31UD08	8	40	11	17	14	15,25
31UD10	10	42	13	19	17	18,43
31UD12	12	43	14	22	19	20,30
31UD15	15	46	16	27	24	25,96
31UD18	18	48	16	32	27	36,50
31UD22	22	52	20	36	32	52,37
31UD28	28	54	21	41	41	76,48
31UD35	35	63	20	50	46	112,17
31UD42	42	66	21	60	55	150,70

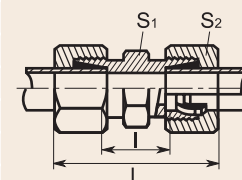

CODO DOBLE



31CD06	6	27	12	14	12	20,85
31CD08	8	29	14	17	12	23,28
31CD10	10	30	15	19	14	23,88
31CD12	12	32	17	22	17	28,09
31CD15	15	36	21	27	19	41,26
31CD18	18	40	23,5	32	24	53,44
31CD22	22	44	27,5	36	27	88,35
31CD28	28	47	30,5	41	36	121,00
31CD35	35	56	34,5	50	41	209,03
31CD42	42	63	40	60	50	294,42

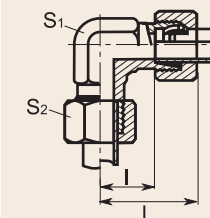

REF.	Ø	S ₁	S ₂	S ₃	L ₂	L ₃	l ₂	l ₃	€/Ud.
------	---	----------------	----------------	----------------	----------------	----------------	----------------	----------------	-------

PASAMUROS



31UP06	6	17	14	17	22	42	7	27	21,62
31UP08	8	19	17	19	23	42	8	27	24,97
31UP10	10	22	19	22	25	43	10	28	29,81
31UP12	12	24	22	24	25	44	10	29	32,71
31UP15	15	27	27	30	27	46	12	31	46,30
31UP18	18	32	32	36	30	49	13,5	32,5	64,82
31UP22	22	36	36	41	33	51	16,5	34,5	87,59
31UP28	28	41	41	46	35	52	18,5	35	116,92
31UP35	35	50	50	55	40	58	18,5	36,5	168,32
31UP42	42	60	60	65	42	59	19	36	232,98

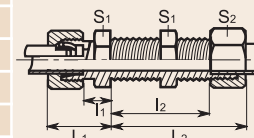

ACCESORIOS DE COMPRESIÓN DIN-2353 (ACERO INOXIDABLE AISI-316)

COMPRESSION FITTINGS DIN-2353 (STAINLESS STEEL AISI-316) _ RACCORDS À COMPRESSION (ACIER INOXYDABLE AISI-316) _
SCHNEIDRINGVERSCHRAUBUNGEN NACH DIN-2353 (ROSTFREIEM EDELSTAHL AISI-316)

REF.	Ø	S ₁	S ₂	L ₂	I	I ₂	I ₃	€/Ud.
------	---	----------------	----------------	----------------	---	----------------	----------------	-------

TE MACHO



31TM06X18	6 x 1/8"	9	12	21	8	9.5	17	34,31
31TM06X14	6 x 1/4"	12	17	31	12	16	26	-
31TM08X14	8 x 1/4"	12	17	29	12	14	26	34,34
31TM10X14	10 x 1/4"	14	19	30	12	15	27	37,81
31TM10X38	10 x 3/8"	17	22	34	12	17.5	28	-
31TM12X38	12 x 3/8"	17	22	32	12	17	28	45,02
31TM15X12	15 x 1/2"	19	27	36	12	21	34	58,09
31TM18X12	18 x 1/2"	24	32	40	14	23.5	36	90,97
31TM22X34	22 x 3/4"	27	36	44	16	27.5	42	*
31TM28X10	28 x 1"	36	41	47	18	30.5	48	*
31TM35X114	35 x 1 1/4"	41	50	56	20	34.5	54	*
31TM42X112	42 x 1 1/2"	50	60	63	22	40	61	*

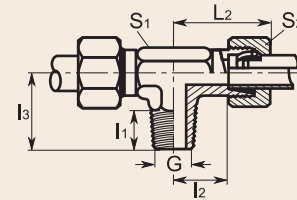

REF.	Ø	L	I	S ₁	S ₂	€/Ud.
------	---	---	---	----------------	----------------	-------

TE IGUAL



31TI06	6	27	12	14	12	28,35
31TI08	8	29	14	17	12	31,85
31TI10	10	30	15	19	14	36,09
31TI12	12	32	17	22	17	39,66
31TI15	15	36	21	27	19	56,40
31TI18	18	40	23.5	32	24	76,46
31TI22	22	44	27.5	36	27	109,59
31TI28	28	47	30.5	41	36	167,30
31TI35	35	56	34.5	50	41	288,71
31TI42	42	63	40	60	50	396,55

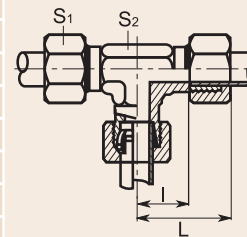

ACCESORIOS DE COMPRESIÓN DIN-2353 (ACERO INOXIDABLE AISI-316)

COMPRESSION FITTINGS DIN-2353 (STAINLESS STEEL AISI-316) _ RACCORDS À COMPRESSION (ACIER INOXYDABLE AISI-316) _
SCHNEIDRINGVERSCHRAUBUNGEN NACH DIN-2353 (ROSTFREIEM EDELSTAHL AISI-316)

REF.	Ø	L	I	S ₁	S ₂	€/Ud.
------	---	---	---	----------------	----------------	-------

UNIÓN MACHO



31UM06X14	6 x 1/4"	37,5	23	14	17	13,07
31UM06X38	6 x 3/8"	39	24	14	19	17,31
31UM06X12	6 x 1/2"	43,5	29	14	22	19,35
31UM08X14	8 x 1/4"	38	23	17	17	10,11
31UM08X38	8 x 3/8"	39	24	17	19	16,23
31UM08X12	8 x 1/2"	44	29	17	22	19,64
31UM10X14	10 x 1/4"	39	24	19	17	11,99
31UM10X38	10 x 3/8"	40	25	19	19	16,52
31UM10X12	10 x 1/2"	45	30	19	22	21,55
31UM12X14	12 x 1/4"	40	25	22	19	16,17
31UM12X38	12 x 3/8"	40	25	22	19	14,19
31UM12X12	12 x 1/2"	45	30	22	22	20,09
31UM15X38	15 x 3/8"	41	26	27	24	20,85
31UM15X12	15 x 1/2"	46	31	27	24	21,14
31UM15X34	15 x 3/4"	46	32	27	27	30,77
31UM18X12	18 x 1/2"	48	31,5	32	27	27,13
31UM18X34	18 x 3/4"	48	31,5	32	27	35,20
31UM22X34	22 x 3/4"	50	33,5	36	32	35,61
31UM22X10	22 x 1"	56	39,5	36	36	48,21
31UM28X10	28 x 1"	46	39,5	41	41	55,61
31UM28X114	28 x 1 1/4"	58	41,5	41	46	-
31UM35X10	35 x 1"	61	39,5	50	46	79,84
31UM35X114	35 x 1 1/4"	62	40,5	50	46	-
31UM42X114	42 x 1 1/4"	65	42	60	55	419,12
31UM42X112	42 x 1 1/2"	65	42	60	55	262,70

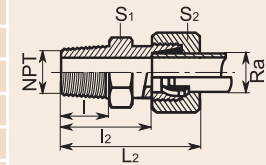

CODO MACHO



31CM06X14	6 x 1/4"	27	12	14	12	19,35
31CM06X38	6 x 3/8"	27	12	14	14	-
31CM08X14	8 x 1/4"	29	14	17	12	22,89
31CM08X12	8 x 1/2"	29	15	17	17	29,81
31CM10X14	10 x 1/4"	30	17	19	14	19,07
31CM10X38	10 x 3/8"	32	15	19	14	22,13
31CM10X12	10 x 1/2"	30	17	19	17	29,17
31CM12X14	12 x 1/4"	32	17	22	17	24,58
31CM12X38	12 x 3/8"	32	17	22	17	22,83
31CM12X12	12 x 1/2"	32	17	22	19	31,57
31CM15X12	15 x 1/2"	36	21	27	19	32,36
31CM18X12	18 x 1/2"	40	23,5	32	24	46,30
31CM22X34	22 x 3/4"	44	27,5	36	27	*
31CM28X10	28 x 1"	47	30,5	41	36	*
31CM35X114	35 x 1 1/4"	56	34,5	50	41	*
31CM42X112	42 x 1 1/2"	63	40	60	50	*

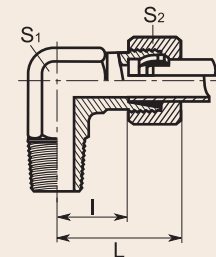

ACCESORIOS DE COMPRESIÓN DIN-2353 (ACERO INOXIDABLE AISI-316)

COMPRESSION FITTINGS DIN-2353 (STAINLESS STEEL AISI-316)_ RACCORDS À COMPRESSION (ACIER INOXYDABLE AISI-316)_
SCHNEIDRINGVERSCHRAUBUNGEN NACH DIN-2353 (ROSTFREIEM EDELSTAHL AISI-316)

REF.	Ø	L	I	S ₁	S ₂	€/Ud.
------	---	---	---	----------------	----------------	-------

ENCHUFE RÁPIDO HEMBRA



31ERH14	1/4"	-	-	-	-	*
31ERH38	3/8"	-	-	-	-	*
31ERH12	1/2"	-	-	-	-	*
31ERH34	3/4"	-	-	-	-	*
31ERH1	1"	-	-	-	-	*
31ERH114	1 1/4"	-	-	-	-	*
31ERH112	1 1/2"	-	-	-	-	*
31ERH2	2"	-	-	-	-	*

ENCHUFE RÁPIDO MACHO



31ERM14	1/4"	-	-	-	-	*
31ERM38	3/8"	-	-	-	-	*
31ERM12	1/2"	-	-	-	-	*
31ERM34	3/4"	-	-	-	-	*
31ERM1	1"	-	-	-	-	*
31ERM114	1 1/4"	-	-	-	-	*
31ERM112	1 1/2"	-	-	-	-	*
31ERM2	2"	-	-	-	-	*

VALVULA BOLA PN 500 AISI-316



63VPN50038	3/8	-	-	-	-	*
63VPN50012	1/2	-	-	-	-	*



CERTIFICADOS_
 CERTIFICATES_ CERTIFICATS_ BESCHEINIGUNGEN





FILTUBE S.A.

Sant Adrià, 76 -E- 08030 Barcelona [Spain] - Tel +34 93 223 26 62 - Fax +34 93 223 26 67
www.filtube.com - customer@inoxidables.com



REDINOX S.A.

Via faraday, 35 -E- 15090 POL. DEL TAMBRE - Apartado 461 -E- 15780 SANTIAGO [Spain] - Tel +34 98 158 64 33 - Fax +34 98 158 23 91
www.redinox.com - redinox@redinox.com



TUBINOX.FILPRES AÇOS INOXIDÁVEIS LDA.

Rua Antero de Quental, 360 - Lote 5 - 4455-586 Perafita [Portugal] - Tel +35 122 998 34 80 - Fax +34 122 998 34 89
www.filpres.com - comercial@filpres.com

