

ARTICULO: 2401

Válvula de Retención tipo wafer de doble disco Check Valve (double disk) wafer type

Características

1. Válvula de retención doble disco tipo wafer.
2. Construcción en Fund. EN-GJL-250 (GG-25).
3. Disco en Acero Inoxidable 1.4408 (CF8M).
4. Eje y resorte en Acero Inoxidable AISI 316.
5. Asiento Nitrilo (NBR) vulcanizado en ranura.
6. Montaje entre bridas EN 1092 PN10/16 y ANSI 150
7. Instalación Horizontal, Vertical o Inclinada.
8. Cáncamo de sujeción incluido a partir de 10".
9. Longitud entre caras según EN 558-1.
10. Presión de trabajo máxima 16 bar.
11. Temperatura de Trabajo -10 °C +100 °C.

Features

1. Wafer check valve (double disk).
2. Made of Cast Iron EN-GJL-250 (GG-25).
3. Disk made of Stainless Steel 1.4408 (CF8M).
4. Axle and spring made of AISI 316.
5. Seat of NBR vulcanised in groove.
6. Assembly between flanges EN1092 PN10/16 and ANSI150.
7. Installed in vertical, horizontal or inclined position.
8. Handling eyebolt included from size 10".
9. Face to Face according to EN 558-1.
10. Max. working pressure 16 bar.
11. Working temperature -10 °C +100 °C.

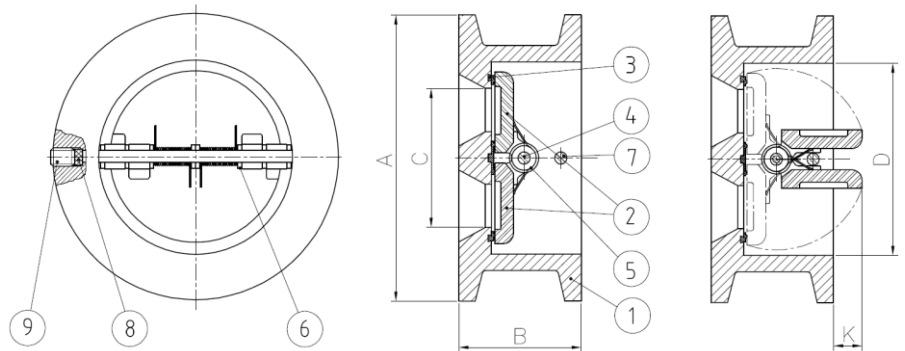

Nº	Denominación / Name	Material	Acabado Superficial / Surface Treatment	Cód. Recambio Spare Part Code
1	Cuerpo / Body	Hierro Fundido / Cast iron EN-GJL-250	Pintura Epoxi / Epoxy Painted	-----
2	Disco / Disk	Acero Inox / SS 1.4408	Granallado / Shot blasting	-----
3	Asiento / Seat	NBR	-----	-----
4	Eje / Axle	Acero Inox / SS AISI 316	-----	-----
5*	Resorte / Spring	Acero Inox / SS AISI 316	-----	K2401
6*	Arandela / Washer	PTFE	-----	K2401
7	Tope Disco / Disk Stopper	Acero Inox / SS AISI 316	-----	-----
8*	Tapón / Plug	NBR	-----	K2401
9*	Prisionero / Grub Screw	Acero Inox / SS AISI 304	-----	K2401

* Piezas de recambio disponibles / Available spare parts

DIMENSIONES GENERALES / GENERAL DIMENSIONS

Ref	Medida / Size	DN	PN	Dimensiones / Dimensions (mm)					Peso / Weight (Kg)
				A	B	C	D	K	
2401 09	2 "	50	16	101	54	48	66	5	1.500
2401 10	2 1/2 "	65	16	119	54	59	80	11	2.050
2401 11	3 "	80	16	133	57	72	95	11	2.700
2401 12	4 "	100	16	164	64	90	117	24	4.100
2401 13	5 "	125	16	194	70	110	145	34	6.450
2401 14	6 "	150	16	220	76	135	170	43	7.900
2401 16	8 "	200	16	275	95	175	224	67	15.800
2401 18	10 "	250	16	328	108	224	265	80	23.000
2401 20	12 "	300	16	378	143	262	312	96	40.500

Detalle de Asiento / Seat Detail

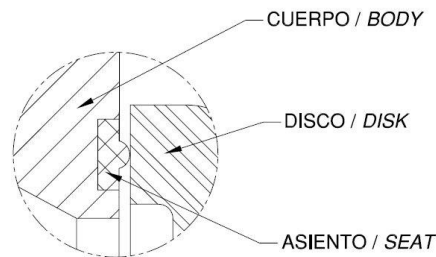

MÍNIMA PRESION DE APERTURA / MINIMUM OPENING PRESSURE

Es la mínima presión necesaria para empezar a abrir la válvula. Se mide con muelles y en posición de fluido ascendente (aire) / Minimum pressure needed to start opening the valve. Measured with springs and fluid upwards (air).

Med. / Size	MOP (mbar)
2"	35
2 1/2"	40
3"	45
4"	50
5"	55
6"	60
8"	65
10"	70
12"	75

VALORES DE Kv / Kv VALUES

Kv = Es la cantidad de metros cúbicos por hora que pasará a través de la válvula generando una pérdida de carga de 1 bar.

Kv = The rate of flow of water in cubic meter per hour that will generate a pressure drop of 1 bar across the valve.

D	Inch	2"	2 1/2"	3"	4"	5"	6"	8"	10"	12"
Kv	m ³ /h	68	111	206	266	455	813	1132	1950	2300

DIAGRAMA DE PERDIDAS DE CARGA / HEAD LOSSES DIAGRAM

(H₂O – 20 °C Flujo Horizontal / Horizontal flow).

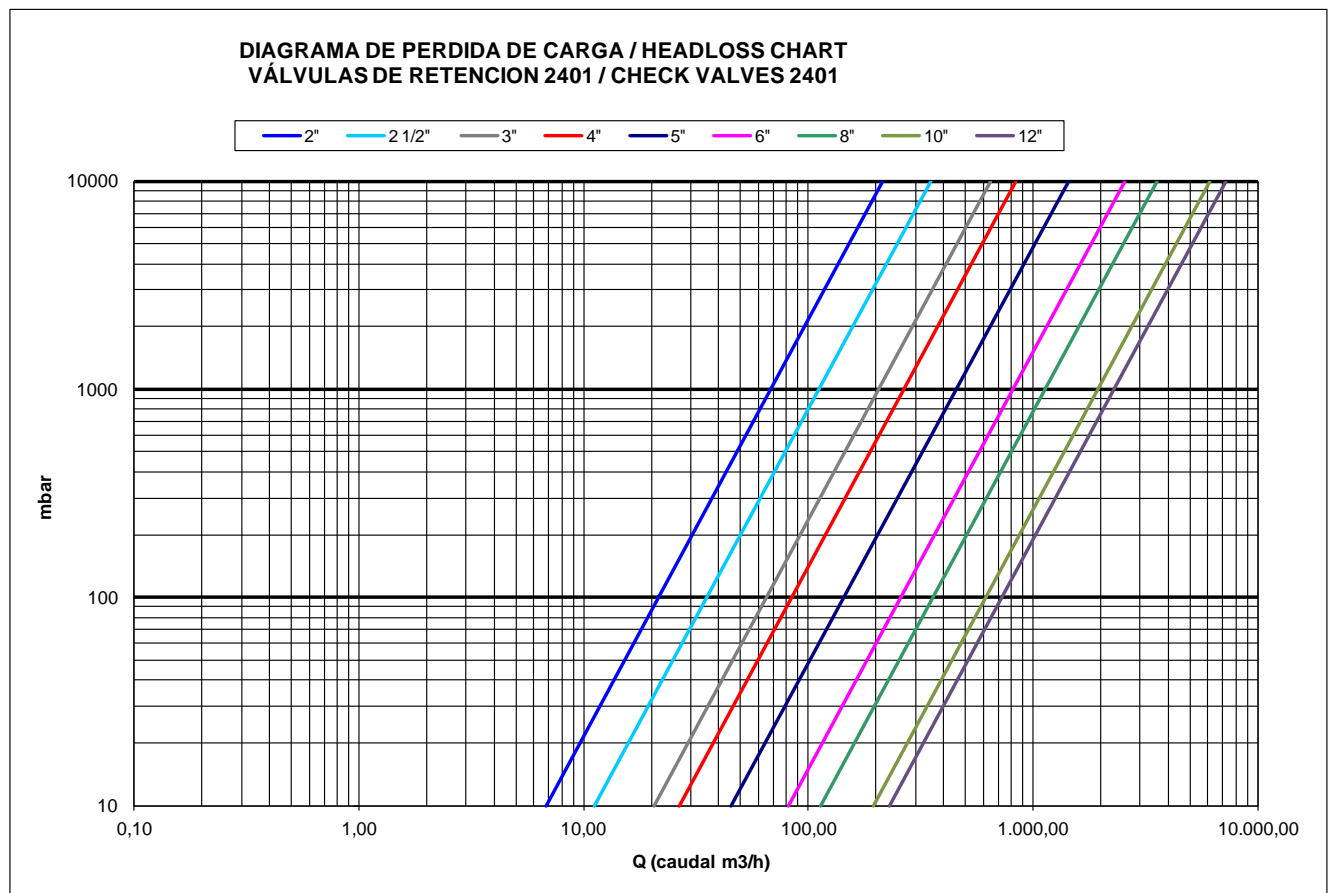

CURVA PRESION TEMPERATURA / PRESSURE TEMPERATURE RATING

